

Wireless World

ELECTRONICS, RADIO, TELEVISION

OCTOBER 1959

Managing Editor:

HUGH S. POCOCK, M.I.E.E.

Editor:

F. L. DEVEREUX, B.Sc.

Assistant Editors:

H. W. BARNARD

T. E. IVALL

VOLUME 65 NO. 9

PRICE: TWO SHILLINGS

FORTY-NINTH YEAR

OF PUBLICATION

- 421 Editorial Comment
- 422 What Goes Wrong with TV? *By W. Oliver & J. Elworthy*
- 426 International Congress on Acoustics
- 429 Airshow Electronics
- 432 World of Wireless
- 434 Personalities
- 435 News from the Industry
- 437 The National Radio Show—in Retrospect
- 448 Elements of Electronic Circuits—6 *By J. M. Peters*
- 449 International Firato in Amsterdam
- 451 Technical Notebook
- 453 Hum, Rumble and Noise *By R. E. Cooke*
- 456 Paris Radio Show
- 457 Short-wave Conditions
- 458 Ferroelectrics—3 *By J. C. Burfoot*
- 463 Ferrite-Cored Aerials *By "Cathode Ray"*
- 467 Designing a Transistor Receiver—2. *By T. Snowball*
- 470 Forthcoming Meetings
- 472 Random Radiations *By "Diallist"*
- 474 Unbiased *By "Free Grid"*

Offices: Dorset House, Stamford Street, London, S.E.1

Please address to Editor, Advertisement Manager,
or Publisher, as appropriate

© Iliffe & Sons Ltd. 1959. Permission in writing from the Editor must first be obtained before letterpress or illustrations are reproduced from this journal. Brief abstracts or comments are allowed provided acknowledgment to the journal is given.

PUBLISHED MONTHLY (4th Monday of preceding month) by ILIFFE & SONS LTD., Dorset House, Stamford Street, London, S.E.1. Telephone: Waterloo 3333 (65 lines). Telegrams: "Iliffepres, Sedist, London." Annual Subscriptions: Home and Overseas £1 15s. 0d. Canada and U.S.A. \$5.00. Second-class mail privileges authorised at New York, N.Y. BRANCH OFFICES: BIRMINGHAM: King Edward House, New Street, 2. Telephone: Midland 7191. COVENTRY: 8-10, Corporation Street. Telephone: Coventry 25210. GLASGOW: 26B, Renfield Street, C.2. Telephone: Central 1265. MANCHESTER: 260, Deansgate, 3. Telephone: Blackfriars 4412. NEW YORK OFFICE: U.S.A.: 111, Broadway, 6. Telephone: Digby 9-1197.

FRAME GRID VALVES FOR TELEVISION

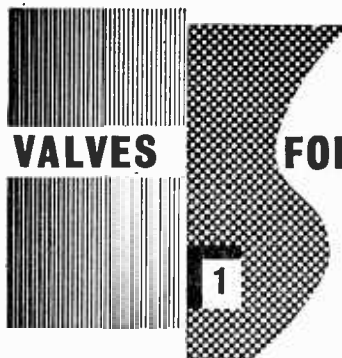

INTRODUCTION

The introduction of frame grid valves into the signal and intermediate frequency stages of the television receiver is a substantial and significant advance. When used in circuits which are not radically different from present practice, frame grid valves greatly increase the gain which is obtainable in the successive stages. Thus, a tuner designed round frame grid valves can have an overall gain of say 58dB, compared with the 48dB or so obtained with conventional valves. A major improvement is also obtainable in the i.f. stages. In receivers which have used three video i.f. stages, only two are now required.

BETTER PERFORMANCE

The advantages provided by frame grid valves may be summed up as: more gain per stage, better signal-handling ability, improved noise factor, and reduced cross-modulation.

A 'frame-grid' receiver in the normal reception areas shows a better performance for a given signal at the aerial. In fringe areas the improved performance can mean that specially modified receivers or elaborate aerials will often be unnecessary; the fringe area is, in fact, pushed further out, while, close to the transmitter, the risk of sound-on-vision is much reduced.

A 'frame-grid' receiver in the normal reception areas shows a better performance for a given signal at the aerial. In fringe areas the improved performance can mean that specially modified receivers or elaborate aerials will often be unnecessary; the fringe area is, in fact, pushed further out, while, close to the transmitter, the risk of sound-on-vision is much reduced.

HIGH SLOPE

A frame grid valve is a high slope valve. In particular, it is a valve with an increased ratio of slope to grid-anode capacitance: that is, it has a good 'figure of merit', and high stage gain is achieved with the minimum of capacitive loading and loss of bandwidth.

High slope is a question of valve geometry. Briefly, for high slope it is necessary to have thin and closely-wound grid wires, and a very small clearance between grid and cathode. The obvious mechanical limitations to the achievement of high slope have been countered by the use of the frame grid. This device is a stiff rectangular frame on which extremely thin grid wires are wound under tension. The side-pieces of the frame are made to close tolerances, so that the finished grid consists of two perfectly flat, rigid, and parallel meshes of fine wire which are held a precise distance apart. A precision cathode is inserted between these meshes, and the

required grid-cathode clearances are ensured by suitable mounting arrangements.

With this sort of technique there is a much reduced need to make allowances for mechanical irregularities or for initial distortion or subsequent displacement of the grid windings. In fact the clearance between cathode and grid can be reduced to give slopes twice as great as those of conventional valves without risking grid-cathode shorts.

TELEVISION RANGE

The first Mullard frame grid valve for television is the PCC89 double triode for cascode r.f. stages. It is already widely used. Three more types will be introduced shortly: the PCF86 triode-pentode frequency changer; the EF183 variable-mu pentode for sound or vision i.f. stages; and a straight i.f. pentode, the EF184.

The EF183, which will be discussed in detail in the next advertisement in this series, has a slope of 12.5mA/V, comparing with 6.0mA/V for the EF85. The improvement in gain is of the order of 6dB in each i.f. stage.

The PCF86 has a slope of 12mA/V, compared with the 6.2mA/V of the PCF80, and the conversion conductance is 4.5mA/V instead of 2.1mA/V. Use of the PCF86 doubles the gain of the mixer stage. A substantially improved noise factor is obtained in a front end in which the PCF86 is preceded by the PCC89.

CIRCUITS

It should be noted that these new types cannot be used as direct plug-in replacements for earlier types. Valve pinning may not be the same; and, in any event, the improved characteristics of the frame grid types necessitate changes in circuit values. Detailed information will be given in subsequent advertisements.

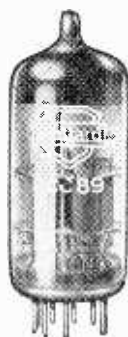

PCC89



MULLARD LIMITED

MULLARD HOUSE,
TORRINGTON PLACE,
LONDON, W.C.1

International Conferences

SOME while ago we discussed the activities of engineers in association and the value of discussion in groups which ranged from the chance meeting of individuals to the formal meetings of the established institutions and learned societies. We did not then extend the argument to the even larger gatherings of the international congresses, conventions and symposia which now seem to be growing in number and frequency. Although in our field the convention and the conference are never likely to be used just as an excuse for an outing, or to become as conspicuous a part of national life as they are in America, it is nevertheless significant that one begins to recognize familiar faces at many of the events covered by this journal in the course of the year. As things go it will soon be a whole-time job to go the rounds. Indeed, the French have already coined a word, *congressistes*, which seems to accord tacit recognition of the vocational attributes of the participants.

International conferences have many advantages and fulfil many functions, perhaps the most important of which is the provision of a focal point in time and place for stocktaking. In accepting membership of a congress one sets aside a period for revision, for the absorption of new ideas and for a chance to see one's own work in perspective against the broader horizons of the subject.

Second, it humanizes the often arid processes of disseminating information. It enables us, so to speak, to judge the character of a witness under cross-examination; ultimate decisions will be made objectively, as they are in interpreting civil law, but the early processes of assessing new scientific knowledge are often helped if one has heard the evidence rather than read the "court proceedings." A congress is also the occasion for innumerable informal discussions outside the conference hall, and, as Professor Ingerslev said in closing the formal proceedings of the I.C.A. in Stuttgart, there is also a build-up and a decay time which considerably extends the usefulness of every event of this kind.

Finally, the published proceedings of a conference bring together in one volume information which would otherwise remain scattered throughout the literature. The Radiolocation Convention organized by the I.E.E. in 1946 set the pattern for many subsequent conferences in combining comprehensive survey papers by acknowledged authorities, with shorter papers on specialized subjects, many of which have subsequently come to be recognized as classics. The proceedings of this Convention are still a useful source for the radar designer.

There can be no doubt of the value and importance

of conferences of this calibre, and it is essential that they should continue to play their part in solving the problem of assimilating and putting on record the vast output of scientific and technical knowledge in the world today. But there is a serious possibility that the situation may get out of hand if too many conferences are held—perhaps from a misguided sense of prestige. Where several societies can lay some claim to an interest in a new subject it is natural that they should each want to run a conference on it. In the early stages it may be difficult to decide who is best qualified to undertake the organization in a way which will anticipate the needs of participants (who ultimately will decide the matter by giving or withholding their support). There can be no question of any form of constraint, but that is not to say that a policy of reasonable restraint on the part of executive councils would be unwelcome to potential *congressistes*.

That restraint should continue to be exercised, after a convention has been decided upon, in the admission of papers. If the time and effort of participants is not to be dissipated or diluted, any paper which serves only as a pretext for self-advertisement should be rigorously excluded. The decision should rest with referees whose authority, open-mindedness and integrity are accepted by the majority.

Having assured the quality the next step is to decide on how to handle the quantity. If this is too large the expedient of running concurrent sessions on separate subjects may not prove to be entirely effective; there are cross-linkages which cut across any attempts at simple segregation.

The obvious solution is to vary the time interval between conferences according to the rate of development of the subject. As things go this must mean more conferences—a vicious circle which can be broken only by judicious pruning of the material submitted for presentation and by the closest collaboration between organizers to ensure that there is the minimum of overlap. This might also help to thaw the cold wars between rival institutions.

We feel that the time is ripe for an International Conference on Conferences to establish a clearing house for dates and to draw up a code of practice for the benefit of inexperienced organizers. This code would no doubt make obligatory the circulation of advance proofs of all papers, or, if this proved to be impossible, the provision of a simultaneous translation system. In the absence of the printed paper the crucial point of a discourse is too easily obscured by the use of a word missing from one's vocabulary of the language; it may even be obliterated by a cough!

What Goes Wrong with TV?

SURVEY OF OVER 1,000 TELEVISION-RECEIVER REPAIRS

These articles are based on data from two different parts of the country—W. Oliver obtained his information in a coastal area where the Band-I signal is not strong and a Band-III service is only available when propagation conditions are good. The "local" transmitter has been in operation in this area for about four years. J. Elworthy, on the other hand, is a service engineer in suburban London, only a few miles away from the transmitters.

PART I—By W. OLIVER

THE survey* of faults encountered in servicing 600 radio receivers brought to light some unexpected and interesting points about radio-set failures. In view of this it was decided to carry out a similar investigation into the various faults which occur commonly in present-day television sets. The facts and figures in the radio-fault analysis were based on first-hand experience by the writer; but the present survey is in the nature of a "composite picture" covering a wider field and it is built up from material supplied by local dealers and service engineers, who went to considerable trouble to provide full and accurate details of their experiences over the past year or so. The mass of information extracted from their servicing records has been analysed and condensed into the summary of faults which follows.

The faults encountered in the servicing areas covered by this survey may not, of course, be typical of those found in other parts of the country. There seems to be a tendency for certain brands of receiver to become popular in certain districts; and each individual make may be prone to faults which are more or less peculiar to those designs. But the collection of data from several dealers should make allowance for this, and also for any element of chance or coincidence: even so, the facts which emerge from the survey are still rather remarkable and somewhat unexpected.

As so many of the components and valves in a television receiver are basically similar to, or identical with, those used in radio receivers, one might reasonably expect that the general trend of faults would also be similar. On comparing the two surveys, however, one finds that valve failures loom much larger in the field of television, while component failures seem to be noticeably fewer. When one considers the large number of small items, such as fixed resistors, potentiometers, fixed condensers, etc., which are used in a modern television set, the small number of component breakdowns which occurred in the sets under review is truly surprising. Nearly half the repairs out of a total of 500 jobs called for no component replacements whatsoever. In no fewer than 245 cases, all that was needed to restore the set to normal working order was to fit one or two new valves.

Analysis of the total new valves fitted brought to light another interesting point: most of the valve failures occurred in just a few types, which cropped up over and over again in the records of replacements.

In the 500 sets already mentioned faulty rectifiers accounted for the biggest total, with 104 in all. Of these, more than half were indirectly heated, high-voltage half-wave rectifiers—i.e., in the e.h.t. class. Of any single specialised class of valve, the type which needed most frequent replacement was the output pentode-with-triode class. No less than 80 of these valves failed, as compared with 34 triode-pentode frequency-changers and 34 r.f. pentodes.

To get a really fair idea of the relative expectation of life of these different classes of valves, however, one must take into consideration the fact that an average television receiver contains more r.f. pentodes (owing to the several i.f. stages employed in sound and vision amplifiers) than either triode-pentodes or output pentodes-with-triodes. On making due allowance for this factor, one realises that the ratio of 80 to 34 is misleading. The first figure could reasonably be multiplied by anything from three to six in order to arrive at a truer comparison on a valve-for-valve basis.

It seems as though valves of the frequency-changer class tend, on average, to have a better expectation of life in a television set than in a radio receiver, judging by a comparison between the present television survey and the radio one published previously. The 600 sets in the radio survey needed 79 replacements of frequency-changers. Allowing for the fact that there is normally only one f/c valve in the ordinary broadcast receiver; but often as many as three of this type (though admittedly used for different purposes) in the typical television receiver, the ratio is much higher than appears at first glance. One must remember, however, that the majority of the radio sets involved were considerably older than the general run of television receivers; consequently some of the radio-set frequency changers which had to be replaced had already enjoyed a very long life. On the other hand, the total of replacements was greatly swelled by casualties in portable sets, particularly those using miniature all-glass types.

Replacements of valves classed as line-timebase-output pentodes totalled 45, double triodes 21, efficiency diodes 14, video output pentodes 13, double diodes 4 and all other types, such as double-diode-triodes and a.f. output valves, together amounted to twenty. Although 50 different types of valves were needed to cope with these jobs, a bare dozen would have sufficed to meet the majority of cases, because most of the casualties occurred, as already shown, amongst a very limited selection of types.

The details already quoted were compiled from the records relating to customers' accounts and cover

* "What Goes Wrong?" By W. Oliver. *Wireless World*, Nov., 1958, p. 522.

only those valves which were actually chargeable. In addition to this total of 369 valves fitted, a further 117 valves which failed while still under guarantee were returned for free replacement, so the grand total was 486. This may sound a lot; but it averages less than one valve per job, which is not bad when one considers that there are likely to be between 15 and 20 valves in each set.

Turning now to cathode-ray tubes, 47 were replaced altogether. Nine of these had failed during their initial guarantee-period; the remaining 38 had outlived their guarantee.

So much for valves and c.r. tubes. Components and accessories provide a very different story. On the whole, the standard of reliability appeared to be quite remarkable, having regard to the large number of parts involved. For instance, in the course of 500 jobs there was not a single instance of an i.f. transformer having to be replaced. (In the radio survey the corresponding score was 4.) Only one loudspeaker gave trouble (as compared with 5 in the radio analysis) and only one valveholder had to be replaced (compared with 10 in the 600 radio sets). Other necessary replacements included 15

frame-output transformers, 5 line-output transformers, 3 sound-output transformers, 2 line-oscillator transformers, 3 "crystal" diodes, 3 thermistors, 3 faulty scan coils and 3 faulty tuning turrets. In addition, 3 booster transformers were fitted. Incidentally, a report from a dealer in another coastal area (not covered by this survey) stated that considerable trouble was caused by transformer breakdowns. Apparently the moisture-proofing of some transformers is not adequate to prevent the ingress of salt-laden air.

A total of 41 fixed capacitors had to be replaced. Two interesting points emerge on splitting up this total: there were only 10 faulty electrolytics (as compared with 63 in the radio survey!) and one solitary silvered-mica type. Possibly the greater average age of the radio sets accounted for the much larger number of new electrolytics needed.

Resistors scored the biggest total: 46 fixed resistors had to be replaced, a very similar number to those in the radio survey; and 44 variable resistors or potentiometers were needed, half of the latter being volume-controls. One of the dealers who co-operated in the present survey was particu-

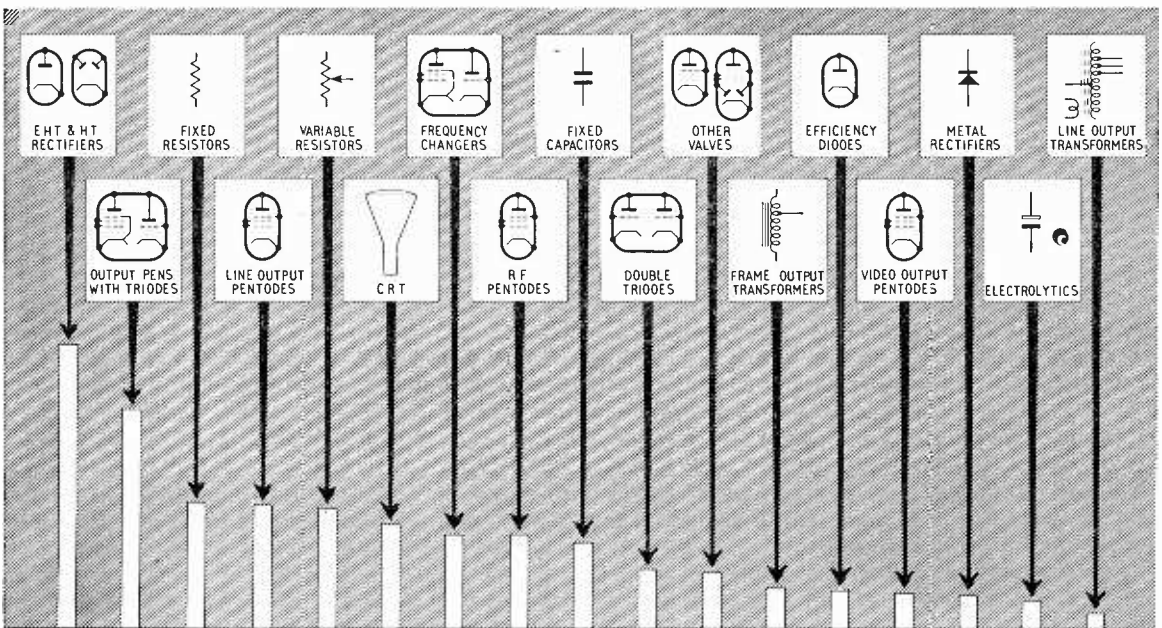

COMPONENT OR VALVE	Number Replaced	COMPONENT OR VALUE	Number Replaced
Valve h.t. and e.h.t. rectifiers	104	Line-output transformers	5
Output pentodes-with-triodes	80	Double diodes	4
Fixed resistors	46	Fuses	4
Line-timebase output pentodes	45	A.F.-output transformers	3
Variable resistors	44	"Crystal" diodes	3
Cathode-ray tubes	38	Scanning coils	3
Triode-pentode frequency changers	34	Thermistors	3
R.F. pentodes	34	Turret tuners	3
Fixed capacitors	31	Line-oscillator transformers	2
Double triodes (r.f. and general purpose)	21	Pilot lamps	2
Other valves	20	Trimmers	2
Frame-output transformers	15	Loudspeakers	1
Efficiency diodes	14	Valveholders	1
Video-output pentodes (special types)	13		
Metal rectifiers	12		
Electrolytic capacitors	10		
		Total Number of valve replacements	369
		Total number of service calls	500

larly emphatic about the amount of trouble he had experienced with volume controls. He considered them to be one of the least-reliable "fixed-in" components in a modern receiver; many of them showed signs of contact troubles almost from the start and on the whole did not compare at all well with those commonly encountered in the older types of radio set. (In some cases, noisiness was accentuated by the fact that the volume control served also as a grid leak; a slight modification of the design would have reduced this tendency.)

A few breakdowns, which should have been avoided, were caused through careless disposition of the components in the physical layout, set assemblers having moved "meltable" items (small "suspended-in-wiring" components containing thermoplastic materials such as polystyrene) into positions too close to hot-running resistors.

Among "queer" faults was a tendency for a

certain type of output valve to crack neatly and completely in a perfectly straight horizontal line around the top of the base! It looked just as though the glass "envelope" had been deliberately sliced off just above the top of the valve-base.

Wiring faults were few, but the occasional dry joint proved very troublesome and elusive when it did occur. In one set, a joint which showed signs of never having been soldered properly in the factory, but had nevertheless made contact after a fashion for three years, eventually gave trouble—and took two days' work to locate!

A dozen metal rectifiers failed, half of these being the contact-cooled type. Only 4 fuses needed renewal (after remedying the fault which caused the fuse to blow), two trimmers suffered mechanical damage and a fine-tuner developed a fault. Finally, two burned-out pilot lamps complete the list of replacements needed in the 500 jobs under review.

PART II—By J. ELWORTHY

A PAIR of date limits were set and the television receiver repairs effected during the period between them were analysed and tabulated. 557 service calls were made; but this number includes 138 calls involving only adjustments to receivers. The adjustments varied from serious misalignment of pre-set controls, through "cleaning the screen" to the resetting to lower values of mains-voltage adjustments during the winter months.

Of all the components in television receivers the triode-output-pentode valve has proved the least reliable. In the 419 repairs requiring component replacements, 82 of these valves had to be replaced. The predominant fault seems to be the development of inter-electrode leaks, which usually results in damage to the bias resistor due to an increase of cathode current. Another common fault is of heater-cathode insulation breakdown—this, too, damages the bias resistor and the valves in the upper end of the heater chain, by over-running their heaters.

In frame timebases using separate valves for the oscillator and output stages 27 valve failures occurred—21 of these were in the output stage and again inter-electrode leaks were the cause of some of the failures; but another common effect was loss of emission causing a non-linear frame scan. Oscillator valves were responsible for the other six failures.

Line-output valves (65 replaced), too, develop inter-electrode leaks which cause damage to circuit components. The more frequent offenders are the miniature types, which work at high temperatures and sometimes suffer from cracked envelopes: octal-based valves seem more reliable and very few valves of this type have needed replacement. Fifty-nine e.h.t. rectifiers failed: the usual fault was an open-circuit heater, but in some valves the whole cathode assembly had broken away from its support, causing an anode-to-cathode short. Line-timebase oscillator valves are listed separately at 54—these were mainly double triodes, and they had to be replaced because of erratic behaviour, usually when used as multivibrators in flywheel-controlled circuits. Another minor cause of erratic flywheel-timebase action was found to be the small metal rectifiers commonly used in the error detector cir-

cuits: four of these have needed replacement. Whilst on the subject of line timebases, it is worth noting that, considering the arduous conditions under which they work, efficiency diodes have a fairly good record. Only 14 required replacement in the total of 557 calls. Line-timebase output transformers were replaced in 10 cases—usually because of a breakdown of insulation between turns.

Variable resistors have a high failure rate, 65 were replaced in all, and 16 of these were faulty line or frame hold controls, which caused erratic locking of the timebase oscillators. Volume controls caused a great deal of trouble, especially when combined with a switch. Twenty-six double controls (used usually for "volume" and "brightness") were replaced, mainly because of noisy volume-control sections or faulty switches: only a few controls were replaced because the brightness section failed, and then only when this section was ganged to the switch. In contrast to "pre-set" potentiometers very few individual volume controls needed replacement; the majority of the remainder of 23 variable resistors were volume controls ganged to the mains switch; again these became noisy.

The high number of fixed resistors (62) should be regarded with caution—many resistors have been fitted to coil biscuits in turret tuners to reduce the strength of the B.B.C. signal. However, about half of the number were actual replacements—these being confined mainly to timebase circuits in applications such as cathode bias and oscillator circuits.

Forty-one replacements of the triode-high-slope-pentode type of valve used as a frequency changer were made. Although these valves are often used for functions other than frequency-changing, those replaced were, in the main, used as frequency changers; the faults making replacement necessary included erratic tuning and modulation hum on Band-III channels. The most common fault that occurred in the "cascode" type of r.f. double triode was a loss of gain; although some failures were caused by inter-electrode leaks. The total number of r.f. double triodes replaced is 24. No record was kept of mechanical adjustments to tuner units when other work was done on a receiver; but 19 calls for service were made due to erratic behaviour of the tuner alone. In most cases cleaning and lubri-

cating the contacts was all that was necessary and this often formed part of the service when the receiver was faulty in other respects.

The most-common valve in a television receiver is the high-slope r.f. pentode, as it is used in i.f.-amplifier, video-amplifier and synchronizing-separator functions in many receivers; therefore it is not surprising to find these fairly high on the list with 42 replacements. The impression gained is that very few have been replaced in functions other than as i.f. amplifiers; but most receivers have only one video amplifier and one sync. separator compared with four or five i.f. stages.

Faulty paper capacitors numbered 23—usually a leak or short circuit necessitated replacement; but some open-circuited units were found. Open circuits were the rule rather than the exception with electrolytic capacitors. The usual symptom was, of course, hum; but other effects included poor frame linearity and instability. In all, 18 units were replaced. Slightly more reliable than both paper and electrolytic capacitors were the small mica and ceramic types—a total of 14 of these needed replacement.

Eighteen "metal" h.t. rectifiers had to be replaced. The directly-air-cooled type failed catastrophically, leaving behind the characteristic and most-unpleasant smell of burned selenium. Contact-cooled types seem not to die, but fade away, gradually reducing h.t. voltages and picture size.

Seventeen h.t. rectifiers failed: faults included "flash over" (which blew the h.t. fuse) and the normal end-of-life loss of emission. Only three valves suffered open-circuit heaters, and one of these was in a series-connected heater circuit.

The figure for c.r. tube replacements (18) would be higher were it not for the preference of many people to buy a new set when the tube in an old receiver fails: a common tube fault was an internal short-circuit of part of the tube heater, which, in a series-heater chain, results in a drop in cathode temperature and emission. Grid-to-cathode shorts, resulting in uncontrollable brilliance, and low emission are two more common faults.

Aerials: in this group, responsible for 15 calls, Band-III additions to existing Band-I aerials are included. Often when an old set is replaced by a new one, a satisfactory picture is received on the existing aerial for the B.B.C. channel, and the customer is reluctant to pay for an additional Band-III aerial. However, as the receiver ages the noise level on the I.T.A. picture rises, and a separate Band-III aerial is then the cheapest and most long-lasting remedy.

The remaining faults form a very small part of the total—5 small diode valves and three mains droppers indicate that these components are not particularly troublesome and the total of 13 miscellaneous individual failures includes line- and frame-oscillator transformers.

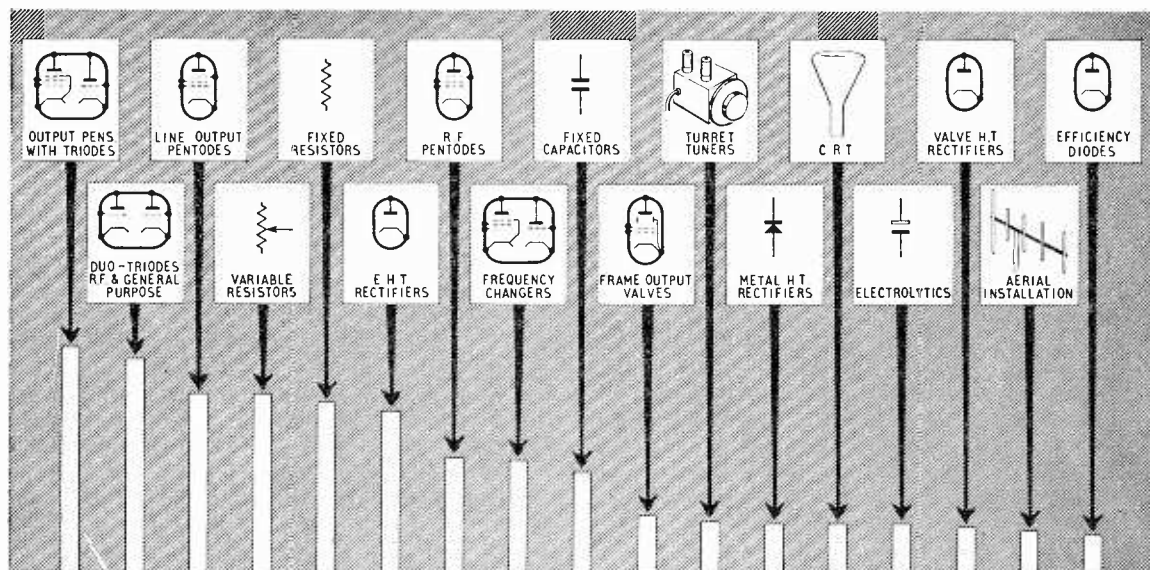

COMPONENT OR VALVE	Number Replaced	COMPONENT OR VALVE	Number Replaced
Output pentodes-with-triodes	82	Cathode-ray tubes	18
Double triodes (r.f. and general purpose)... ..	78	Electrolytic capacitors	18
Line-timebase-output valves	65	Valve h.t. rectifiers	17
Variable resistors	65	Aerials	15
Fixed resistors	62	Efficiency diodes	14
Valve e.h.t. rectifiers	59	Line-output transformers	10
R. F. pentodes	42	Small valve diodes	5
Triode-pentode frequency changers	41	Mains-dropping resistors	3
Fixed capacitors	37		
Individual frame-timebase-output valves	21		
Mechanical attention to turret tuners	19		
Metal h.t. rectifiers	18		
		Total number of valve replacements	424
		Total number of service calls	557



Outside the Physikalisches Institut, Stuttgart. Much of the value of the Congress was the opportunity afforded for informal discussion.

International Congress on Acoustics

TOPICS DISCUSSED AT THIS YEAR'S MEETING IN STUTTART

SINCE this series of conferences was initiated in Delft in 1953 by the International Commission on Acoustics (under the auspices of U.N.E.S.C.O.) there has been a phenomenal increase of activity and considerable widening of the scope of the subject. At Delft the number of papers read (in three concurrent sessions) totalled 90; at Cambridge, Mass. in 1956 the number was 260; at Stuttgart this year there were no fewer than 350 discourses by authors from 26 countries. Fourteen invited papers by acknowledged authorities were given in the mornings in the large lecture theatre of the Physikalisches Institut and were open to as many of the 1,200 members attending the Congress as could find seats. The remainder of the contributed papers (in German, English, French or Italian) were given in the afternoons, either at the Physikalisches Institut, or, a short bus ride away, at the Technical High School. No advance copies of papers were available and authors were restricted to a 15-minute talk, followed by 5 minutes of discussion. To get through the work in eight days (1st to 8th September) it became necessary to run eight sessions concurrently, and while this to some extent solved the problem for the narrow specialist it increased the difficulties of those charged with the responsibility of viewing the subject as a whole. The following notes are of necessity somewhat selective and arbitrary but they will have served their purpose if they indicate the direction in which inquiry is proceeding and some of the results so far obtained. The full proceedings will be published in the spring (by Elsevier) and will be available to non-participants as well as members of the Congress.

Electroacoustics: Transducers

Investigations by G. E. Martin (U.S.A.) into the relative merits of commercially available magnetic materials for use in electromagnetic (variable reluctance) transducers have led him to the conclusion that grain-oriented silicon steel best meets the criteria of bandwidth, power output and efficiency. Work is proceeding on new materials with a view to bettering this performance.

Playback heads for magnetic tape, using the Hall effect were discussed by F. Kuhrt (Germany). The output does not depend on rate of change of flux and so differs from inductive heads in being independent of frequency. In practice a wafer of indium-antimonide, at right angles to the tape, is sandwiched between two ferrite blocks which come together at the bottom to form the usual working gap in contact with the tape. The magnetic flux is thus made to traverse the thickness of the wafer. A polarizing current is passed along its length and the output e.m.f., which may be as much as $500\mu\text{V}$, appears at right angles to this current.

A paper by J. Greiner (Germany) on the hum pick-up in magnetic tape recorders underlined the importance of ensuring that any residual field is parallel rather than at right angles to the plane passing through the front and back gaps of the recording heads. He compared the plotted random field on the surface of an early tape deck design with the uni-directional field in a more recent product.

No fundamentally new principle appeared in the loudspeakers discussed at the Congress, but an interesting modern version of the Beyer principle using a lightweight conductor grid on a light plastic diaphragm and a ferrite magnet system was described by M. R. Gamzon (Israel).

Monitoring loudspeakers with special directional characteristics to localize the sound in mobile TV control vans were described by D. E. L. Shorter (England) who also showed how small line-source loudspeakers and monitor screens are used to maintain contact between singer, orchestra and conductor on large studio sets. By mounting two small unbaffled loudspeakers close together on the same axis and feeding them in opposite phase a figure-of-eight directivity is obtained. If the input bandwidth is restricted to two octaves this loudspeaker can be mounted on top of the studio microphone and used for conducting interviews between people in widely separated studios.

Acoustic feedback in sound reinforcement (public address) systems is reduced by inserting a constant frequency shift between microphone and loudspeaker in

a system described by M. R. Schroeder (U.S.A.). This is accomplished by modulating a 20kc/s carrier and then extracting one sideband after beating with a second oscillator. If the shift is made equal to the mean distance between peaks and troughs in the gain-frequency response of the room energy built up in the peaks is absorbed in the troughs after one circuit round the loop and about 10dB more gain can be used before instability is reached. In a demonstration tape recording using a 5-c/s shift the beat between original and reinforced sound could be just heard (after it was pointed out) but was insufficient to interfere with speech.

Delay lines for low frequencies in the form of twisted tape, under tension- and stiffness-controlled conditions, were discussed by G. Ashley and R. M. Lerner (U.S.A.). These have distortionless characteristics and propagation velocities as low as 0.01 of the shear velocity in an unbounded medium. A composite magnetostrictive delay line technique described by J. F. W. Bell has been used to determine the elastic constants of a wide variety of solids, e.g. graphite, alumina, fused quartz and metals at temperatures up to 1000°C.

Electromechanical filters using thick circular discs coupled by thin rods and driven by magnetostrictive transducers were discussed by R. L. Sharma (U.S.A.). With centre frequencies of 50kc/s to 500kc/s, these filters find application in high-performance communications receivers, single-sideband and carrier equipment. W. P. Mason and R. N. Thurston (U.S.A.) described bandpass filters for frequencies below 20kc/s which are milled or pressed from sheet metal and consist of parallel bars joined at their centres by short torsional elements. The pass-band is associated with anti-symmetric flexural vibration of the bars.

Piezoelectric transducers in the form of paste in a high-viscosity medium have been used by A. Lutsch (South Africa) for application *in situ* to specimens for non-destructive testing and the determination of elastic constants. Cylindrical transducers radiating along the major axis were discussed by A. A. Ananjeva (U.S.S.R.). They depend upon periodic distribution along the cylinder of velocities normal to the surface to give a principal lobe of directivity at grazing angles to the surface. Coaxially mounted piezoelectric cylinders acting as capacitors in a low-pass artificial line and described by W. J. Trott (U.S.A.) generate a progressively increasing wave in the water within the tube. At a given frequency there is an optimum length at which the electrical and acoustical phase velocities are equal; at this point no electrical energy remains. High efficiency, low Q and constant impedance are claimed for this design.

Spark discharge generators of underwater sound with efficiencies of 30% were described by N. A. Roy and D. P. Frolov (U.S.S.R.). For the generation of **micro-second sound pulses** at pressures up to 100 atmospheres W. Eisenmenger (Germany) uses eddy current reaction in a copper foil induced by capacitor discharge through an adjacent spiral coil. Rise times of less than 10^{-7} sec in the shock-wave front have been observed.

Room Acoustics : Musical Acoustics

The majority of the papers on room acoustics dealt with absorbers for amelioration of reverberation characteristics. C. L. S. Gilford and N. C. H. Druce (England) described wide-band absorbers consisting of thin layers of porous material with impermeable facings in which a high coefficient of absorption is maintained up to the natural resonance of the system, which occurs at a high frequency. Investigations of rockwool absorbers by W. Löchstätter (Norway) have revealed deep and narrow absorption maxima in the region of 100c/s which have been shown to be due to vibrations of the fibres themselves.

Model concert halls have often been used for the inves-

tigation of their acoustic properties, sometimes with light rays to reveal reflections, but a much more ambitious scheme using **stereophonic ultrasonics** was described by R. Boutros-Attia (Egypt). A stereo tape recording is made at normal speed, played back at increased speed through ultrasonic transducers in the model, picked up by microphones in an artificial head inside the model, and again recorded and finally played back at slow speed and compared with the original sound. Drying apparatus is used to reduce the relative humidity inside the model.

A. F. B. Nickson and R. W. Muncey (Australia) expressed the opinion that measurements obtained from models were insufficient for predicting the acceptability of designs. The response of individuals to tests with artificially added echoes has shown broad tolerance of acoustic conditions. It is suggested that the detail supplied by acoustical measurements is not matched by a corresponding subjective response. On the other hand V. L. Jordan (Denmark) gave the results of subjective tests which showed that orchestral players' judgment of concert hall quality is related to the amount of first reflections received by the orchestra. Studies by M. Lukacs (Hungary) have shown a relationship between reverberation (1.5 to 2.5 sec) and the musical tempo preferred by 60 persons in 480 musical judgments. As might be expected the longer the reverberation time, the slower the preferred tempo. The programming of a digital computer for the generation of conventional and new music was demonstrated by M. V. Mathews and N. Guttman (U.S.A.).

Physiological and Psychological Acoustics

Although the mechanism of hearing as far as the output from the cochlea is concerned is now reasonably well understood, the processes of the central nervous system and the mechanism of perception still await a satisfactory explanation. A. von Murlat (Switzerland), in a lecture of exemplary clarity outlining present knowledge of the physical chemistry of nerve pulse generation and the important role of sodium and potassium, said that little was yet known of the causes of the catastrophic increase of permeability of the nerve cell wall by sodium which was the origin of the electrical "firing" pulse. In an endeavour to find more about the nerve processes and the relationship between stimulus and sensation, G. von Békésy (U.S.A.) reported experiments on the distribution of sensitivity with frequency of stimulus along the human forearm which has features in some ways similar to those of the basilar membrane and cochlea. S. S. Stevens (U.S.A.) in a paper read for him by J. C. R. Licklider proposed modifications of the Fechner law relating stimulus and sensation and adduced evidence in support from a comparison of the exponents of the power functions relating psychological magnitude to stimulus magnitude for such widely differing "prothetic continua" as loudness, brightness, smell, taste, temperature, vibration, heaviness, force of hand-grip, vocal effort and electric shock.

The masking of one sound by another has in the past been the subject of a vast number of experiments involving simultaneous masking and "residual" masking when the masked signal is delivered after the masking tone has been cut off. I. K. Samoilova (U.S.S.R.) pointed out that masking can still take place when the masked signal *precedes* the masking signal and is separated from it by a certain interval of time.

Noise

The social problem of increasing noise, as part of the price to be paid for the advance of technology, was admirably presented in an exhibition "Weniger Lärm" ("Less Noise"), arranged by the Industrial Central Office of the province of Baden-Württemberg. This was a comprehensive collection of typical noise sources—motorcycles, circular saws, teleprinters, etc., and of the

means that have been successfully adopted in either reducing the source or screening the output of noise. There can be little doubt that noise reduction is being more actively pursued in Germany than in most countries, and during a scientific excursion to Munich, members of the Congress were able to appreciate the success of the efforts which have been made by the German railways to reduce wheel noise by the use of bonded rubber layers between tyre and wheel boss, aerodynamic noise by streamlining and double windows (fixed) with air conditioning. These and other methods account for the phenomenal quietness of, for example, the Trans Europa Express diesel trains.

Studies of aviation acoustics are being urgently pursued, not only in the interest of people in the vicinity of aerodromes, but because at speeds approaching that of sound the energy radiated from aerodynamic turbulence may exceed the jet noise and may even induce serious vibration of the airframe. It was pointed out by H. E. von Gierke (U.S.A.) that the noise from wake vortices increases as the 6th power of the speed, as does jet noise with the exit velocity. An interesting feature of jet noise is that there is no acoustic radiation from the supersonic speed region close to the nozzle and that most of the sound energy comes from a region from 30 to 40 nozzle diameters further downstream. The frequency of maximum spectral energy in the noise increases as the nozzle diameter is reduced and this fact is exploited in so-called jet silencers with perforated walls. As von Gierke pointed out they are not silencers but noise sources from which the energy is emitted at supersonic frequencies rather than audible frequencies. The energy is consequently more rapidly dissipated in propagation through the atmosphere. The difficulties of relating turbulence in a moving jet stream to sound at a fixed distant point were underlined by E. J. Richards (England) who described the use of space-time correlation techniques in conjunction with hot-wire microphones in the region of maximum shear at the jet boundary.

Less virulent noise sources, such as piston engine test beds, car tyres and typewriters, which formed the subject of other papers may be said to have descended the loudness scale to the point where restrictive legislation is feasible, and it was interesting to learn from a paper contributed by R. Levi *et al.* (Brazil), that protection against noises from "vehicles, machinery, motors, compressors, stationary generators, loudspeakers, radios, orchestras, apparatus of all kinds and industrial establishments" is now provided for the citizens of Sao Paulo by a law passed in 1958. The maximum permissible levels are between 85 and 45dB, depending on whether the zone is wholly industrial or residential. In Russia, according to a paper by I. I. Slavin and J. M. Ijaschtschuk three classes of noise spectra are recognized (low, middle and high frequency) each with a permissible upper limit of intensity. In many other countries such criteria are regarded as an oversimplification, and debate and research continue in an effort to find a valid, or at any rate a reasonable, correlation between objective measurements and subjective nuisance.

Molecular Acoustics

One of the most spectacular advances in "acoustics" has been the progressive lifting of the upper limit of frequency of mechanical vibration first into the Mc/s and now into the kMc/s region. The absorption of ultrasonic and what is now coming to be termed "hypersonic" vibration in gases, liquids and solids is providing very valuable information on the structure of matter to supplement that already obtained from X-rays and infra-red radiation. From the frequency and shape of absorption lines and bands and their associated relaxation times many clues are provided of the transitions of atomic order in complex organic molecules. J. Lamb (England) and his colleagues at Imperial College contributed several papers describing amongst other things investigations into lubricating oils and substituted

ethanes. An invited paper by H. Oberst (Germany) showed the extent to which acoustical methods are employed in plastics research, development and testing. They are also providing new light on dilute electrolytic solutions (A. Barone and D. Sette, Italy) and steam at high pressures and temperatures (R. B. Lindsay *et al.*, U.S.A.).

To those unacquainted with the rapid advance in this field the idea of molecular acoustics may have sounded a little far-fetched; no doubt they will regard the terms **atomic and electronic acoustics** as wholly fantastic, but those who were privileged to hear the lecture by R. W. Morse (U.S.A.) on ultrasonics in metals at very low temperatures can have little doubt of their validity. At temperatures at which the mean free path of electrons in the crystal lattice of pure metals is of the same order as the ultrasonic wavelength there is absorption due to scattering of energy by electrons in the direction of propagation of the acoustic field. The electron movement is equivalent to an elliptical orbit and the attenuation of the acoustic energy is modified. By rotating the magnetic field relative to the sound field the shape of the Fermi surface (bounding the occupied electron states) relative to the crystal axes has been deduced and has been found in the case of copper to be not spherical but of approximately cubic form with rounded corners. Investigations of the electron structure of tin have revealed a sharp fall in "sound" absorption at the transition temperature. Exploration by the above-mentioned magneto-acoustic technique has shown that the superconductivity is anisotropic.

Miscellaneous

Many interesting and unusual applications of acoustics, which do not fall easily into any of the broad divisions so far discussed, were the subject of individual contributions and are worth mentioning to show the range and variety of the subject.

The new **vehicle tunnels** which are now a feature of many Continental cities pose special problems of noise control, which were discussed in papers by O. J. van Os and P. A. de Lange (Holland) and A. C. Raes (Belgium).

Motor horns are intended primarily for giving audible warning of approach to pedestrians, but are equally important in "communicating" with other motorists. T. Lange (Germany) discussed the results of tests to determine the best frequency spectrum for penetrating wind noise.

Wind speeds can be measured over a base line of 2.5cm by an **acoustic micromanometer** described by A. S. Gurvitch (U.S.S.R.). The phase change of ultrasonic sound gives a measure of the velocity of the medium.

Better combustion and a higher temperature in oil-fired furnaces is possible according to P. Greguss (Hungary) if an acoustic field is maintained in the region of the flame.

Acoustic drying of porous sheet materials offers advantages in some industrial processes, and R. M. G. Boucher (U.S.A.) reviewed the present state of the art. Minimum intensities of 145dB at 6 to 10kc/s are necessary and at present the method is effective for thicknesses of 2in or less.

Looking to the future, I. Dyer (U.S.A.) discussed the noise environment to be expected in space vehicles.

If progress continues at this pace the 4th Congress, which is to be held in 1962 in Copenhagen under the chairmanship of Prof. Dr. F. Ingerslev, will have a formidable task in keeping the subject matter within the bounds of a single conference—even perhaps of finding accommodation for the increasing number of scientists who are now paying court to Acoustics—the one-time Cinderella of the sciences.

Airshow Electronics

Review of Trends, Progress and Equipment at the S.B.A.C. Exhibition, Farnborough

IN the "static" exhibition it was the exception, rather than the rule, to find a stand without some form of electronics on show. This is, perhaps, not surprising when one considers that at least 20% of the cost of a modern airliner is its electronics and that a V-bomber may contain as much as half-a-million pounds worth of radar, wireless and control equipment.

Automatic Control: Modern flying conditions, both as regards speed and traffic density, make great demands on the personnel involved. Thus it is logical that equipment, whether it be for the use of the air traffic controller or the pilot, should perform automatically many of the functions previously carried out mentally and manually. The last few years have seen great progress in data handling and processing techniques on the ground. This year the main emphasis at the show was on the use of automatic control in the air, so that the pilot does not need, except in an emergency, to fly the aircraft; instead he supervises the operation of the automatic equipment. Of course, "auto pilots" have been with us for many years now; but these, hitherto, have acted in such a way that they preserve, so to speak, the *status quo* of the aircraft with regard to compass heading, height and airspeed. The latest techniques, however, enable absolute information from radio-navigational aids to be fed to the auto pilot.

Especially suitable for deriving this information is Doppler radar, and Marconi have produced two displays incorporating computers for their AD2300 equipment. The smaller of the two (Model B) features distance to go along track and distance to go across track; but the more sophisticated Model C gives latitude and longitude and magnetic variation, which is derived from a three-dimensional cam actuated by the aircraft's position! Both these computers are electromechanical analogue devices which give auto pilot feeds; but the nature of Doppler information—an a.f. tone representing the spectrum centre—makes possible the use of digital techniques on a pulse-counting basis, and this is what Canadian Marconi do in their CMA-601 computer for the CMA-620 series of radar (Janus f.m./c.w. system). Transistor-diode "logic" circuits are used to produce along-track and cross-track distances to go. The control unit is, in part, duplicated (within the one box) so that the next flight leg may be pre-set and at the completion of one flight leg an automatic change-over to the next leg occurs. An interesting feature of the CMA-620 series is that the whole system is self-checking. This is done by periodically and automatically perturbing the tracker unit, and seeing that it returns to the original "lock" condition so that a fault indication is given within 20 seconds or so of the occurrence of the fault. Manual-check facilities similar to those found on ground equipment are given by a meter and rotary switch on the front panel of the tracker unit.

Of course, automatic aircraft guidance is not confined to Doppler radar. Cossor have extended the usefulness of their GEE system by adding a computer. An experimental equipment was shown, in which the c.r.t. indicator had been retained—a fix is made in the normal way, then the circuits are switched in: these operate the computer with a following accuracy of 1/100 of a GEE unit. It is worth mentioning, in passing, other improvements on the GEE r.f. head. A cascade input stage and double-triode oscillator and mixer have enabled noise factors of 1.5dB at 30Mc/s and 2.25dB at 80Mc/s to be realized. This, Cossor say, results in the coverage previously given at 40,000ft now applying at 100ft!

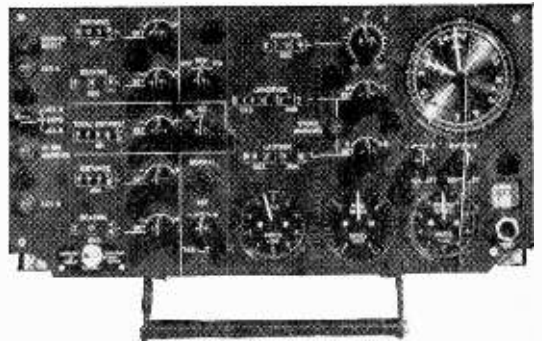

Type 4382 computer and display for Marconi AD2300 Doppler radar. Magnetic variation is given top-centre dial.

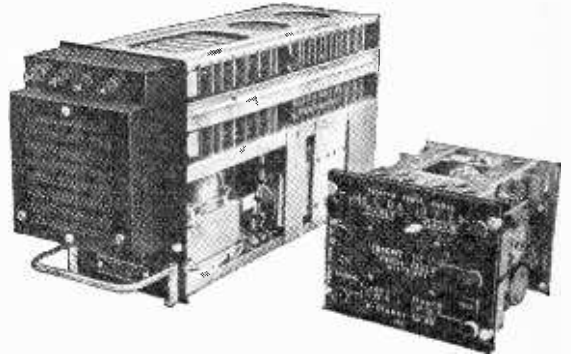

Digital computer, and control and read-out unit for Canadian Marconi Doppler radar.

When using any of the systems noted above with the auto pilot a considerable relief is afforded to the pilot. However, Sperry, carrying the idea yet further, were illustrating the use of a computer to fly the aircraft without external intervention from take-off to landing. Sperry's system, called Radio Track Guide, is aimed, like Cossor's, at exploiting fully the information given by ground-based aids and it is designed to work with practically any such system. This uses an electro-mechanical computer in which the distances travelled across and along track are represented by angular displacements of two centre-tapped potentiometers. At the start of a flight leg (which, incidentally, is "stored" on a punched card) the potentiometer slides are at the earthed centre taps, so their relative potential is zero. They are then displaced by an amount representing the leg, and the inputs to the potentiometer are adjusted until the relative potential is again zero. Thus, during a flight leg the sliders move from the centre taps to the end-of-leg points, and, provided the aircraft is on track, the slider-to-slider potential is always zero. To avoid the carrying of two sets of potentiometers to allow legs to be flown automatically and consecutively the navigational information is deliberately falsified at the end of a leg so that the computer is "held" at the change over point. As soon as the setting-up procedure has finished the deliberately induced "error" is removed and normal tracking continues.

For the landing of the aircraft we now turn to Automatic Blind Landing equipment* developed by B.L.E.U., R.A.E. Bedford on show under the name "Autoland". The equipment consists of an auto pilot (Smiths), a high-accuracy altimeter† (S.T.C.) and a leader-cable installation (Murphy). However, the leader-cable installation itself is inconvenient, as it requires a run of about a mile from the end of the runway. Similarly a phase of "inertial guidance" (constant altitude) has to be employed between the end of accurate I.L.S. guidance (to I.C.A.O. specification) and the start of the altimeter control of height, because the altimeter has to be over level ground for use at low heights. In its present form the equipment uses the I.L.S. glide path guidance down to 150ft. not only to place it in the correct position for entry to "Autoland" control, but also to stabilize the auto pilot for the constant-altitude phase. Thus, although I.L.S. is not a part of the system, Autoland does rely on I.L.S. for part of the final landing procedure. For this reason, then, and in the hope that I.L.S. may eventually prove reliable enough guidance for part of the landing cycle (so reducing the length of the leader-cable), both Pye and S.T.C. have been working to improve the I.L.S. ground equipment. The Pye development consists of the use of slotted-cavity radiators instead of dipoles for the glide-path aerials—these, with their reduced subsidiary lobes and narrower beamwidth, render the glide-path usable down to about 20ft. on a good installation. S.T.C. on the other hand have been attending to the localizer or azimuth aerial. Their STAN 7 set of equipment uses twelve dipoles in front of a straight curtain reflector (Pye use two dipoles and a parabolic reflector). To suppress any false signals from the localizer array, mounted behind it is another array which provides a blanking signal outside the localizer main beam. The S.T.C. equipment makes extensive use of transistors, and one complete localizer and glide path (STAN 8) equipment contains only 28 valves. Automatic monitoring is fitted to both S.T.C. and Pye equipments.

Electronic automatic control is also finding increasing application to fuel control in turbines. The de Havilland Gnome engine which will be used first in helicopters, where the requirement of sudden and frequent power changes is made, together with a constant speed of rotation for the rotor. Using manual control of the engine, flight controls and fuel throttle have to be adjusted simultaneously and correctly if dangerous engine conditions are to be avoided. Mechanical linkages have been used, but these have disadvantages. The Gnome engine-fuel-control system (developed by de Havilland Propellers) uses a small computer which integrates signals feed back from the engine with the pilot's demands to control the fuel supply to the engine. It operates from the 24-V aircraft supply, using transistors and magnetic amplifiers: it ensures that optimum working is achieved under any circumstances and dangerous engine conditions cannot occur.

"Building-block" construction, in which a selection of compatible units to make an equipment exactly to the user's specification without expensive one-off techniques, provides great flexibility and is an increasing trend in ground equipment. It is this which makes a full description of the Redifon G420 series of transmitters impracticable in this report. Covering 1.5 to 30Mc/s this equipment can be used as an a.m./c.w. transmitter of 500W output and, by the addition of other units, be made to encompass the gamut of modulation classifications as an 8-frequency remote-controlled station, with effective powers up to 2kW under some conditions.

We noted last year the debut of the Cossor CRD.23 processed radar display system. This equipment, too, is arranged on the building-block scheme so that practically any requirement of synthetic and live radar information can be handled. It has, too, several very interesting technical details. Primarily designed for

civil use, the number display is rate-aided, and the numbers are generated, as is usual, during inter-scan time; but this period is very much shorter than with some systems, so that the maximum p.r.f. is limited more by maximum range than inter-scan time. The system is completely direct-coupled, the range-scale being set by the level of feedback on the scan amplifiers. It is thus possible to off-centre the display and then switch to a shorter maximum range, when the part of the display in view expands; but is not further off-

Burndept lightweight v.h.f. transceiver. Crystals are housed beneath swing-out cover. Tuning indicator checks power amplifier adjustment.

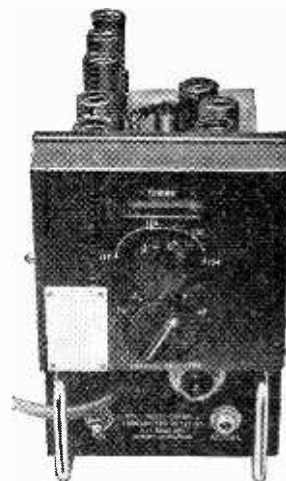

Left: Five-loudspeaker column for Trixadio aircraft p.a. system. Note built-in transistor amplifier with preset level control (at bottom).

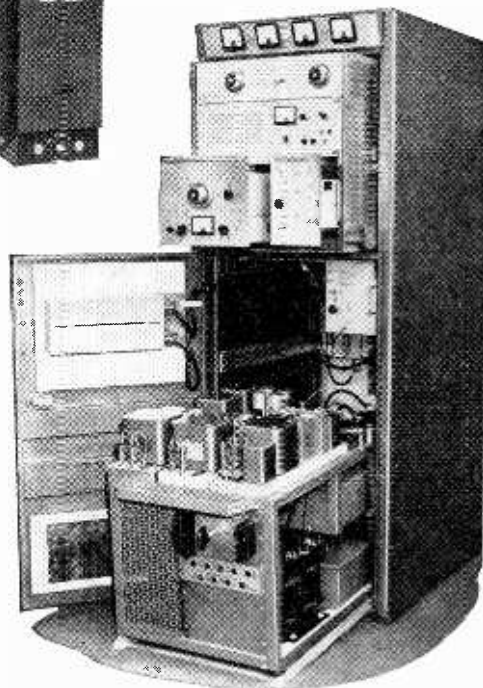
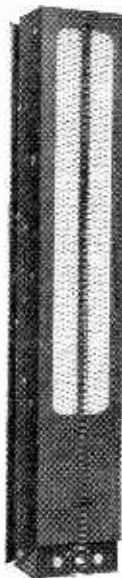

Building block construction of Redifon GA20 series h.f. transmitters. This example is fitted with units for s.s./i.s.f. operation.

* *Wireless World* Vol. 64, p. 579 (December 1958).

† *Wireless World* Vol. 64, p. 492 (October 1958).

Right: Horse-collar construction of de Havilland Propellers' computer (for control of Gnome engine) enables it to fit in engine air intake, for cooling.

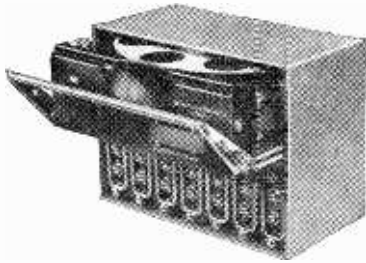

Left: "Midas" cassette - loading flight-data recorder. Spools are placed one above the other in pull-out unit.

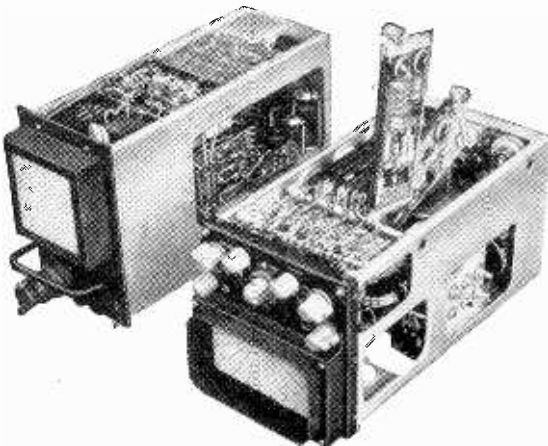

Two units from Ekco E190 airborne radar. Transmitter (left) and display unit (right) with i.f. amplifier, control unit and timebase. Note servicing accessibility given by hinged panels.

centred. No pre-pulse is required, thus triggering from the transmitter pulse can be carried out, so avoiding any chance of jitter due to inaccuracies in the "firing" of the transmitter chain. The secret to all this lies in the deflector-coils, which, although they are of high impedance, have an extremely small self-capacity so that the inevitable ringing on shock excitation is at a high frequency and so dies down very quickly. The whole equipment is "electronic" in its approach—even the rate-aided number shifts are generated with an electrometer valve, and only 12 valve types are used in the whole equipment. Another Corsor Radar, the CR.787, uses a travelling-wave tube as an r.f. amplifier, resulting in a noise factor of 6dB and a 23% increase in range.

Weight reduction greater than the weight of the original equipment consequent on miniaturization sounds ridiculous, but it is true. The new Ekco E190 airborne radar itself weighs only 86lbs. against the 125lbs. of the E160, but the E190 uses only three units

—scanner, display and transmitter—against the six boxes of the E160. Thus cabling and racking are saved and their weight amounts to a total slightly greater than the weight of the E160. This new radar operates on 3cm and has a range of 150 miles! It is almost completely transistorized, and to make possible the economic use of transistors a 13.5-Mc/s i.f. has been used. This leads to a tendency of the klystron a.f.c. circuit to lock on to the image response, but some very ingenious circuitry avoids this difficulty. Whether the klystron reflector voltage rises or falls when the a.f.c. is "searching" depends on a bi-stable transistor switch which is sensitive to the direction of change of voltage of discriminator-output waveform. There are, naturally, two discriminator characteristics "displayed," as the klystron frequency is changed, one being the "mirror image" of the other. If the image response is approached, then the switch reverses the direction of the change of voltage on the klystron reflector so that its output frequency is swept away from the image and back to the correct value. To avoid "hunting" the bi-stable switch can operate only when the klystron reflector voltage is falling. Total power consumption is 300VA and a Polaroid filter is used on the c.r.t.

Aircraft p.a. exhibited a trend towards distribution at low level, using loudspeaker units with integral transistor amplifiers. In this way reliability is increased and weight is saved. Both Elliott and Trix were showing examples—the Trix system uses a small column of five loudspeakers. Whilst the directional effects achieved with only five units might be expected to be small, adequate coverage of a typical aircraft is achieved with three or four columns.

Magnetic Recording.—Several firms were showing magnetic recording apparatus—notably Grundy, Thermionic, Royston and Solartron. The Thermionic Products equipment is a ground-based 20-channel unit designed for registering aircraft communications. It is completely transistorized, but, as there is no "erase" facility, the power requirements for bias are fairly small. The system, like the previous Thermionic and B.C.C. recorders, is self-checking and automatically changes over to another equipment should a fault develop. The Royston "Midas" is an airborne, 8-channel data recorder with a tape-magazine which can be ejected from the aircraft in event of a crash, so preserving the records. Tape speed is 1/10 in/sec and up to 300 signals representing aircraft performance can be recorded by using the built-in time-sharing switch. This recorder, too, uses transistors throughout.

R/T equipment for aircraft service is naturally in the same position as mobile ground equipment; put simply, the trouble is not enough channels. This has led to some exploration of the u.h.f. bands, but a temporary amelioration of the position on v.h.f. is offered by reducing channel spacing. This, of course, renders existing equipment unsatisfactory, so it was interesting to see many manufacturers producing 50kc/s channel-width versions of their 100kc/s v.h.f. equipment. Universally the modifications required include extra crystal ovens to improve stability. Changes of i.f. amplifier strips are fairly common and, last but not least, on the equipments giving all channels, room for double the number of crystals has had to be found. In most cases, though, the external appearance and ease of control of the set have not been changed. A new v.h.f. transceiver from Burndept—the BE255—is designed for light aircraft. Weighing only 6½lbs. complete, it provides five preset channels and uses a transistor power supply. The sensitivity is 10 μ V for 10dB signal-to-noise ratio and the transmitter output is 1W.

W.S. Electronics were showing an airfield communication system: usually one v.h.f. channel is set for essential services, but the nature of the equipment used generally restricts this to communication with motor vehicles. The W.S. system uses an inductive loop motor system for contacting small "walkie-talkie" receivers, and communication back to the base station is made on u.h.f.

WORLD OF WIRELESS

International Study Groups

THE work of the C.C.I.R. (International Radio Consultative Committee), which is one of the permanent organs of the International Telecommunication Union, is continued between international plenary meetings by a number of study groups each covering a specific aspect of the Committee's work.

Two of these study groups, No. IV (concerned with ground-wave propagation) and No. V (covering tropospheric propagation), have now been merged because of the "difficulty of distinguishing the frontier between the fields of study of these two groups." The chairman of the combined group, which is known as study group V, is Dr. R. L. Smith-Rose. A new study group IV has been set up to deal with radio links between earth and space vehicles and between space vehicles themselves. The chairman is Professor I. Ranzi of Italy.

To facilitate the work of the various study groups, of which there are fourteen, member countries of the C.C.I.R. set up *national* counterparts of each of them. Below we list the chairmen of the study groups in this country.

I Transmitters	R. Holden (G.P.O.)
II Receivers	W. R. H. Lowry (G.P.O.)
III Complete systems	R. Holden (G.P.O.)
IV Groundwave and tropospheric propagation	Dr. R. L. Smith-Rose (D.S.I.R.)
V Space vehicles	Dr. J. A. Saxton (D.S.I.R.)
VI Ionosphere propagation	G. Millington (Marconi)
VII Time signals and standard frequencies	R. L. Cooke (G.P.O.)
VIII Monitoring	C. W. Sowton (G.P.O.)
IX General technical questions	W. J. Bray (G.P.O.)
X Broadcasting	W. J. Chalk (B.B.C.)
XI Television	Capt. C. F. Booth (G.P.O.)
XII Tropical broadcasting	J. K. S. Jowett (G.P.O.)
XIII Operation questions	G. H. M. Gleadle (G.P.O.)
XIV Vocabulary	A. K. Dobbie (G.P.O.)

Radio Hobbies Show

A FEATURE of the Radio Hobbies Exhibition, which opens at the Royal Horticultural Society's Old Hall, London, S.W.1, on November 25th, will be a display of over a dozen working communications receivers. These sets, which may be operated by visitors, will be supplied by Airmec, Collins, Eddystone, Geloso, Hallicrafter, Heath-Kit, G.E.C., Marconi, Minimitter, National, Racal, Redifon and Siemens-Ediswan.

Admission to the exhibition, which will be open from 11 to 9 on each of the four days, cost 2s. The exhibitors include:—

A.P.T. Electronics
Avo
British Amateur TV Club
Collins Radio Co.
Daystrom
Electronic & Radio Engineer
Enthoven Solders
Hi-Fi Magazine
Home Radio
Jason Motor & Electronic Co.
K.W. Electronics
Labgear
Mayra Electronics
Minimitter
Mullard

Norman Price
Richard Maurice Equipment Co.
Reida Radio
Short Wave Magazine
Siemens Edison Swan
Taylor Electrical Instruments
Territorial Army
R.A.F.
R.S.G.B.
Radio Constructor
Royal Navy
Scott, James & Co.
U.H.F. Group
Wireless World

T. E. Goldup

WITH the death of Thomas Edward Goldup, C.B.E., on October 6th, at the age of 65, a very well-known figure has been lost to the radio industry and will be especially missed in councils and conferences where radio men meet.

His industrial career had been spent entirely with the Mullard organization which he joined in 1923. He had been a director for over 20 years. His early years with the company were spent at the valve factory at Balham where he later assisted in the setting-up of the Valve Development Laboratory. Reference was made to "his pioneering achievements in the design and development of thermionic tubes and his contributions to the technical and administrative councils of the radio industry" when in 1954 he was elected a Fellow of the American Institute of Radio Engineers.

During the First World War he was in signals in the Royal Navy and on demobilization was appointed senior experimental officer at the Signals School, Portsmouth.

Mr. Goldup's absorbing personal interest in later years was in the educational field. He was a governor of the Ministry of Supply School of Electronics, Malvern, and was on the boards or advisory bodies of a number of educational organizations. He was also a moving spirit in the Mullard Educational Service.

During his tenure of office as president of the I.E.E. (1957/58) he undertook an extensive overseas tour during which he took part in the Commonwealth Engineering Conference in Australia.

Other Obituary Notices are on p. 435.

Commonwealth Telephone Cable

CABLE AND WIRELESS LIMITED have been made responsible for financing, laying and maintaining the United Kingdom's share (approximately half) of the £80M Commonwealth round-the-world telephone cable system. This is announced in the annual report. The Post Office has been assigned the main responsibility for designing and engineering the telephone cables as far as this country is concerned.

Provision is made in a new partnership between C. & W. and the Post Office for the establishment of a joint submarine cable and repeater development unit which will be controlled by R. J. Halsey, Post Office Director of Research, who was elected a director of Cable and Wireless Ltd., at the annual general meeting on July 29th.

Faraday Lecture

THIS session's Faraday lecture of the I.E.E. is being given by Professor M. G. Say and the subject is "electrical machines"—which he defines as converters of energy from, or into, electrical form. In his synopsis he says the loudspeaker is strictly a "machine" producing acoustic from electrical

energy. The lecture will be delivered first at Glasgow on November 25th and repeated at Sheffield (Dec. 1st); Nottingham (Dec. 3rd); Birmingham (Jan. 19th); Cardiff (Jan. 21st); Southampton (Feb. 15th); London (Feb. 17th); Rugby (Feb. 19th); Hanley (March 8th); Liverpool (March 10th) and Dublin (March 14th).

Air Electronics

THE first "maintenance meeting" of the European Airlines Electronics Committee was held in London on September 22nd and 23rd. It was attended by radio and electronics representatives of 11 airlines. By invitation representatives attended from the Air Transport Electronics Council, the Electronic Engineering Association and the Society of British Aircraft Constructors.

The meeting covered radio and instrument systems in aircraft and manufacturers emphasized how valuable it would be to them if airlines could have a common policy on maintenance practice—for example, whether they would wish to continue to overhaul equipment, or would find it advantageous to discard modules which failed.

Inst.P.-Phys. Soc. Merger?—The amalgamation of the Institute of Physics and the Physical Society is foreshadowed in the annual report of the Institute. A scheme for amalgamation is being submitted to members of both bodies. The report also records that the Institute membership of all groups increased by 415 in the year under review, bringing the total to 6,309.

Junior Institution of Engineers.—Two of the 1958/59 awards of the Junior Institution of Engineers are for papers on radio and electronic subjects. The Institution's silver medal is awarded to John Heywood, who is a lecturer in the Department of Telecommunications at the Norwood Technical College, for his paper "Radio measurements on the Russian earth satellites." The Tooke award has been given to W. J. Kease and A. C. Quarterman, who are both in the computer division of E.M.I. Electronics, for their paper "Computers and materials handling."

Dutch Firato.—The total number of visitors to the recent Dutch radio and television exhibition, on which we give a report elsewhere in the issue, was 167,201.

U.S. Television.—Ten per cent of the 45M television equipped homes in the United States have more than one set, making a total of nearly 50M receivers in use. These figures were issued by the Advertising Research Foundation of America.

Electronic Systems Laboratory is the new name adopted by what was previously known as the Servomechanisms Laboratory of the Massachusetts Institute of Technology. The laboratory was established in 1940 and Professor J. F. Reintjes has been director since 1953.

"Designing a Transistor Receiver."—It has been pointed out that the Ferranti ZS10B rectifier (included among the alternatives for the mains unit on p. 367 of the September issue) is rated at 0.1A. The load current in each arm of the bridge rectifier is 0.3A and so the correct Ferranti rectifier is the ZS30B.

Can you help?—A reader is trying to trace a copy of Electronchart No. 1 giving details of an amplifier, which was issued about 10 years ago. Information to D. W. S., c/o Editor.

Memorial to T. L. Eckersley.—A bronze bust of her late husband, who died in February, has been presented to the Marconi Company by Mrs. E. Eckersley. The bronze, which was executed by the late Kathleen Scott, now stands in the Marconi Research and Development Laboratories at Great Baddow, Essex.

Physics of Semiconductors.—The fifth international conference on the physics of semiconductors to be held under the auspices of the International Union of Pure and Applied Physics is being organized by the Czechoslovak Academy of Science. It will be held in Prague from August 29th to September 2nd next year.

Computer Reliability and Maintenance.—A series of discussion meetings is to be held on January 20th and 21st next year at the Institution of Electrical Engineers, Savoy Place, London, W.C.2, which will deal with the managerial and engineering aspects of reliability and maintenance of digital computer systems. The British Computer Society will be responsible for arranging the meetings on the first day. The second day's meetings will be organized by the Measurement and Control Section of the I.E.E.

Dover.—Low-power tests from a temporary 75-foot mast on the site of the I.T.A. station at Church Hougham, near Dover, began towards the end of September. Full-power tests, using the recently completed 750-foot mast, will begin towards the end of November in preparation for the opening of the station by Christmas. The station radiates vertically polarized signals in channel 10. It will be equipped with a directional aerial giving a maximum e.r.p. of 100kW.

Receiving Licences.—Combined television and sound licences in the U.K. increased during August by 77,868, bringing the total to 9,627,657. Sound only licences, total 5,281,581, including 401,981 for sets fitted in cars. The overall total of 14,909,238 was an increase of 226,113 on the August figure last year.

Liverpool College of Technology.—A full-time eight-months' course in electrical engineering in preparation for the I.E.E. Part III examination is being conducted at the Liverpool College of Technology. The course will take the place of the usual two- or three-year part-time day or evening course of study for the examination. The course opened on October 5th, but late entrants will be accepted.

Radar Navigation.—To give ships' Masters and senior deck officers experience in the use of radar as an aid in manœuvring a ship, a radar simulator course has been introduced at the Sir John Cass College, London. The course, which will last five days, is approved by the Ministry of Transport and Civil Aviation and similar courses are expected to be introduced at other colleges shortly.

Pulse Circuit Design.—A course of 23 evening lectures in pulse circuit design began at Twickenham Technical College, Middlesex, on October 8th. The lectures, in which special consideration is being given to circuits using transistors under pulse conditions, are delivered at 7.0 on Thursdays. The college is also conducting a course of 18 lectures on Monday evenings covering computer programming. It began on October 12th.

Hendon Technical College is conducting a number of special courses for advanced students during the Autumn term. Among them is one on industrial electronics for mechanical engineers. It consists of 15 lectures on Tuesday afternoons from October 20th. A course of seven lectures on ultrasonics is being held on Wednesday evenings.

Higher Technological Courses covering a very wide variety of subjects at some 40 colleges in London and the Home Counties are listed in the 1959/60 bulletin issued by the Regional Advisory Council for Technological Education. It costs 3s 6d post free from the Council at Tavistock House South, Tavistock Square, London, W.C.1.

Personalities

Sir Owen Wansbrough-Jones, K.B.E., C.B., Chief Scientist to the Ministry of Supply, has resigned to take up an appointment in industry. He is succeeded by **Robert Cockburn**, C.B., O.B.E., M.Sc., Ph.D., who has been Controller of Guided Weapons and Electronics in the Ministry since 1956. Dr. Cockburn, who is 50, taught physics at Portsmouth and West Ham Municipal Colleges before he joined the radio department at the Royal Aircraft Establishment, Farnborough, in 1937. Two years later he became head of the radio counter-measures division of T.R.E. In 1947 he was awarded the American Medal of Merit for his work in this field. In 1945 he transferred to atomic energy research, and three years later was appointed scientific adviser to the Air Ministry. He has been with the Ministry of Supply since 1954.



Dr. R. Cockburn



J. E. Clark

J. E. Clark, M.I.E.E., managing director of Cathodeon Electronic, Ltd., has been elected to succeed **D. C. Birkinshaw**, M.B.E., M.A., as chairman of the council of the Television Society. Mr. Clark, who is 55, joined Cathodeon as a director in 1950. For the previous 15 years he had been with the Ekco organization; 11 years with E. K. Cole, Ltd., and four years with Ekco-Ensign.

John B. Adams has been appointed by the United Kingdom Atomic Energy Authority to be director of a new establishment to be set up to deal with controlled thermo-nuclear research. The site of this new establishment is not yet decided. During the war Mr. Adams, who is 39, worked at the Telecommunications Research Establishment on the development of centimetric radar. From 1946 to 1953 he was at the Atomic Energy Research Establishment, Harwell, where he was a member of the team which designed and built there the 110-inch diameter cyclotron. Since 1953 he has been working with the proton and synchrotron group of the European Council for Nuclear Research.

C. B. Speedy, Ph.D., B.E., Assoc.I.E.E., has been appointed to the board of Lion Electronic Developments Ltd. Dr. Speedy is also a director of Gresham Developments Ltd. The two companies are associated, the manufacturing facilities of Lion Electronic Developments being used to implement the research, design and development activities of Gresham Developments.

A. Witkin has joined N.G.N. Electrical Ltd., of Accrington, Lancs., as Southern England technical representative for their high-vacuum products. For some time he was doing research work on microwave valves at the G.E.C. Research Laboratories and more recently with the valve research group of Elliott Brothers. He was for a short while in the National Physical Laboratory of the Government of Israel Research Council.

B.I.C. Construction Co. recently announced the appointments of **J. N. Gibson**, **J. R. McDonald**, B.Sc. (Eng.), A.M.I.E.E., and **D. M. H. Rooney**, M.A., A.M.I.E.E., as executive directors. Mr. Gibson became chief supervising engineer in the power cable contracts department of the company in 1949. In 1955 he was appointed manager, submarine cable contracts in B.I.C. Construction Co., and a director of BIC (Submarine Cables) Ltd. Mr. McDonald joined the company in 1958 as contract manager (overseas projects) in the telecommunications cable contracts department. He was in the G.P.O. Engineering Department from 1936 until some time after the war. From 1951 to 1958 he was chief engineer and director of the Jamaica Telephone Co. Mr. Rooney, after a college apprenticeship course with Metropolitan Vickers and five years with the Royal Navy, joined British Insulated Callender's Cables Ltd., as an assistant engineer in the Civil Engineering (Traction) Department. In 1955 he became regional manager for India, Pakistan and Ceylon and a director of BIC (Export) Ltd.

G. H. Metson, Ph.D., M.Sc.(Eng.), M.I.E.E., deputy chief scientific officer in the thermionics division of the Post Office Research Station, Dollis Hill, has been awarded the degree of Doctor of Science by Queen's University, Belfast, for his work on the thermionic valve and particularly on the oxide-coated cathode. Dr. Metson led the team concerned with the development of the long-life steep-slope pentode valves used in the repeaters for the Newfoundland-Nova Scotia section of the first transatlantic telephone cable. He joined the Post Office as a youth-in-training in 1925.

Semiconductors Ltd., the Plessey-Philco company, announces the formation of an executive board headed by **Dr. James Reekie**, who becomes executive director and general manager. Dr. Reekie was in Canada for twelve years before joining the company as chief engineer in 1957. While in Canada he was for some time Professor of Physics at the University of Toronto and immediately prior to returning to this country was research director in semiconductors and solid-state physics of the Northern Electric Co., Montreal. **C. H. Noton**, who recently joined the company as commercial manager, becomes commercial executive director of Semiconductors Ltd. and **E. E. Webster**, central production executive, Swindon Region, of the Plessey Co., is also appointed an executive director.

A. Bodley Scott, D.F.H., M.I.E.E., appointed technical director of Bryans Aeroequipment, Ltd., of Mitcham, Surrey, was an Admiralty scientist specializing in guided weapons, electronics and servo systems, until joining the company 18 months ago.

F. J. Jervis, B.Sc.(Eng.), A.M.Brit.I.R.E., has joined Nash and Thompson Ltd., as contracts manager. He is responsible for all commercial aspects of research, development and manufacturing contract work. Since 1951 he has been a production engineer in the Guided Weapons Department of the Ministry of Supply. Prior to joining the Ministry he had been in industry since 1924, having been with Aerovox Radio Ltd. and All Power Transformers Ltd.

Dr. Harvey Fletcher, Director of Research and Dean at Brigham Young University, Utah, a pioneer in psycho-acoustics, has been appointed an honorary member of the Society of Motion Picture and Television Engineers. The citation refers to the Fletcher-Munson curves on the relation between frequency, intensity, and loudness.

Aubrey Harris, A.M.I.E.E., A.M.Brit.I.R.E., who has been appointed the technical representative in the Fribourg, Switzerland, offices of Ampex International, S.A., will be concerned with video-tape recorder applications. He joined the Ampex Corp. in California last year. From 1952-57 he was with Marconi's at Chelmsford, following which he was for a year chief engineer of Bermuda's commercial television station. He is 30.

L. A. Sweny, manager of Marconi's Aeronautical Division since 1946, has retired and has become a director of Hovercraft Development Ltd. He is 60. Mr. Sweny had been with Marconi's since 1936 except for the period 1942-1946 during which he was for two years in the Fleet Air Arm and for two years Assistant Director of Communications Development (Naval) with the Ministry of Aircraft Production. He was for some years in the Department of Civil Aviation at the Air Ministry and in 1934 was appointed signals officer in charge of the U.K. Civil Aviation Signals Organization. His successor as manager of Marconi's Aeronautical Division is B. J. O'Kane, Ph.D., B.Eng., A.M.I.E.E., who for the past seven years has been the company's chief air radio engineer. In 1935 Dr. O'Kane joined the staff at the G.E.C. Research Laboratories and in 1941 was seconded to the Telecommunications Research Establishment at Malvern. He returned to the G.E.C. in 1945. For his contribution to the development of radar—in particular the north-seeking p.p.i.—he was granted an award by the Royal Commission on Awards to Inventors. From 1947 to 1952 Dr. O'Kane was chief engineer of International Aeradio Ltd.



Dr. B. J. O'Kane



R. E. Cooke

R. E. Cooke, B.Sc.(Eng.), author of the article "Hum, Rumble and Noise," served with the Royal Naval Air Service during the war, working on airborne radio and radar equipment. Subsequently he obtained an honours degree in electrical engineering at London University,

and in 1951 joined the Mullard Radio Valve Co., where he eventually took charge of a section manufacturing cathode-ray tubes. In 1954 Mr. Cooke went to the B.B.C. Designs Department, Recording Section, dealing with problems in disc and tape-recording systems. He is now technical director of Wharfedale Wireless Works which he joined in 1955.

F. Langford-Smith, B.Sc., B.E., head of the Technical Publications Department of the English Electric Valve Co., has been elected an honorary member of the Audio Engineering Society of America in recognition of his contributions to audio engineering through his book "Radio Designer's Handbook." He is a vice-president of the British Sound Recording Association. Mr. Langford-Smith came to this country from Australia in 1957 to join the English Electric Valve Co., at Chelmsford. He had been with Amalgamated Wireless (Australasia) since 1932 where he was for some time engineer-in-charge of the company's valve laboratory.



F. Langford-Smith

Robert L. Cogdale has been appointed European resident technical representative of Marconi Instruments and will reside near Paris.

OBITUARY

Geoffrey Bernard-Baker, design executive in Murphy's television and radio division, died suddenly on August 27th at the age of 52. He was one of a group of young graduates who joined the company's laboratories in 1932 and was a well-known figure in the industry's engineering circles.

Dr. Russell H. Varian, who with his brother Sigurd invented the klystron, died on July 28th, at the age of 61. He was chairman of the board of Varian Associates, of California, which he helped to found in 1948.

News from the Industry

Electric and Musical Industries announce a group net profit for the year ended on June 30th of £2.232M compared with £2.156M last year. The U.K. and overseas taxation absorbed £2.534M compared with £2.573M the previous year.

B.R.W.—Sir Robert Renwick, chairman of British Relay Wireless and Television, Ltd., in his report for the past year announced a group profit, after taxation, of £300,908 compared with £232,418 the previous year.

Radio and Television Trust Ltd.—Daniel D. Prenn, head of Truvox Ltd., has acquired, at a price approaching £500,000, Crompton Parkinson's interest in Radio and Television Trust Ltd. J. V. Daniel, a director of Crompton Parkinson, has resigned his appointment as a director of the Trust, and Mr. Prenn has succeeded him. Crompton Parkinson acquired a controlling interest in the Trust earlier this year. Airmec Ltd., is the manufacturing subsidiary of Radio and Television Trust Ltd.

Dulci Company has been taken over by Lee Products (Great Britain) Ltd. The Dulci factory at Willesden, London, N.W.2. is to continue producing Dulci equipment.

Admiralty W/T Station.—Marconi's supplied 20 of the 30 transmitters referred to in the note on page 391 of our last issue; the remainder being provided by Standard Telephones and Cables. The S.T.C. installation included eight 30-kW h.f. transmitters. B.I. Callender's Cables supplied four 600-foot masts for the long-wave aerials and 58 lattice steel masts for the rhombic aerials. The open wire automatic aerial exchange by which any one of ten transmitters can be connected to any one of twenty aerials was designed, manufactured and installed under contract to the Admiralty by P. & L. Millers Ltd., of London, E.1.

Electric Audio Reproducers, Ltd., of The Square, Isleworth, Middx., which became a subsidiary of the Gas Purification and Chemical Company some time ago, has been re-acquired by L. Stone and two other former directors of the company, E. Kaye and J. R. Sharp.

Raytheon Company, of Waltham, Mass., has appointed Dr. Carlo Calosi to the newly created post of vice-president, Europe. He will be responsible for European production of Raytheon equipment as well as European sales and distribution of their products manufactured both in the U.S. and on the Continent.

Audiotape, the magnetic recording tape manufactured by Audio Devices Inc., of New York, is now available in this country through Lee Products (Great Britain) Ltd., who have been appointed sole concessionaires for the U.K. and Eire.

Marconi Instruments' mobile showroom and demonstration unit, which was used initially at the Farnborough Air Show, is touring the Midlands and the North of England. It is planned to go on a four-month tour of Western Europe next year.

Avo, Ltd., now a member of the Metal Industries Group, has secured a £14,000 order from the Ministry of Supply for portable electronic multi-range measuring instruments of panclimatic construction. The instrument provides 97 measurement ranges which cover a.c. and d.c. current; voltage; r.f.; resistance and also 36 audio power measurements over a range of 120dB.

Marconi's are to supply seventy-five 21-inch picture monitors for the studio production control rooms at the B.B.C.'s new Television Centre. These monitors, Type BD850, are suitable for use on 405, 525 or 625 lines, the change-over from one standard to another being made by four simple wiring modifications and changing one capacitor.

Closed-circuit television for both live and film transmission is among the facilities provided in the film projection theatre equipped by the G.B.-Kalee division of Rank Precision Industries, Ltd., in the May Fair Hotel, London, W.1. Pye equipment is used for the closed-circuit television chain.

Teleng Ltd., is the new name of the company previously known as Telefusion (Engineering Ltd.) They are planning to treble the floor space at their Harold Wood, Essex, factory to increase the production of the Teleng range of television-f.m. relay equipment.

Minns Electronics, of The Lower Mill, Kingston Road, Ewell, Surrey, has been formed to manufacture initially wide-band transformers and amplifiers and test gear for transistor production. The directors, R. H. Minns and S. E. Minns will also act as consultants.

Gothic Electronic Industries, Ltd., of Hampton Street, Birmingham, 19, is the new name adopted by Foresight Productions, Ltd., of the same address. They have recently produced the "Tramp" transistorized portable p.o. amplifier, with built-in loudspeaker, weighing 3½lb with battery. The company's general manager is D. Bates who was previously with Stratton & Co.

EXPORT NEWS

Microwave Telephone Network.—Standard Telephones & Cables installed the equipment for Malaya's first microwave trunk telephone network inaugurated on September 26th. The system, which connects Kuala Lumpur and Singapore with other centres of population, incorporates six radio links interconnected by multiplex channelling equipment. The main route between Kuala Lumpur and Singapore has a capacity of 600 telephone circuits and the spurs 240.

A tropospheric scatter link providing six speech channels between Trinidad and Barbados is to be set up by Cable & Wireless. Marconi's are supplying two 1-kW transmitters for each site. Each transmitter will feed into a 30-ft parabola giving a maximum e.r.p. of 4MW. The Automatic Telephone & Electric Co. are to supply the carrier equipment and compandors, and Marconi Instruments the test equipment.

Yugoslavia.—Marconi Instruments Ltd., are showing their latest telecommunication measurement equipments at the Ljubljana International "Modern Electronics" Fair which is being held from October 16th to 25th.

Transatlantic Telephony.—Nearly half the 4,900 miles of cable for the second transatlantic telephone circuit providing 36 circuits between the U.S. and France, was supplied by Submarine Cables Ltd. The remainder was supplied by companies in France, Germany and America. The fifty-seven one-way repeaters at 38-nautical-mile intervals in each of the two cables (one for each direction of transmission) linking Newfoundland with France were provided by the Western Electric Co., of America. In the 330-nautical-mile section of the cable from Clarenville, Newfoundland, to Sydney Mines, Nova Scotia, there are sixteen two-way repeaters supplied by Standard Telephones & Cables.

Sweden.—A market report on domestic sound and television receivers in Sweden has been issued by the Export Services Branch of the Board of Trade. Before mains receivers can be sold to the public in Sweden they must be approved by SEMKO (Svenska Elektriska Materialkontrollanstalten, Franzengatan 5, Stockholm 30). Seven different makes of U.K.-manufactured television receivers (17-in and 21-in) have received approval. According to the report, about 63% of the country's imports of sound and television receiving equipment in 1957 came from West Germany and 23% from the Netherlands. The U.K. share was 4%—about Kr.5M.

F.M. and television broadcasting equipment valued at approximately £292,000 has been ordered from Marconi's, through their agents Svenska Radioaktiebolaget, by the Royal Board of Swedish Telecommunications. The order includes 16 television transmitters, with associated sound transmitters and ancillary equipment, and 20 f.m. sound broadcasting transmitters.

Surveillance radar equipment has been ordered from Decca for installation at the airports at Malmo, Sweden, and Maiqueta, Caracas. The radar is the D.A.S.R.1 which operates in the S-band (around 3,000 Mc/s).

CLUB NEWS

Barnet.—A demonstrated talk by a representative of Wyndor Recording Co. will be given at the meeting of the Barnet and District Radio Club on October 27th. On November 24th there will be a lecture on aerials for the radio amateur by Ray Hills (G3HRH). The club meets on the last Tuesday of each month at 8.0 at The Red Lion Hotel, High Barnet.

Bexleyheath.—"International Amateur Radio" is the title of the talk to be given by Arthur Milne (G2MI) at the meeting of the North Kent Radio Society on November 26th. The club meets at 8.0 at the Congregational Hall, Chapel Road.

Cheam.—J. F. H. Aspinwall, of Redifon's communications laboratory, will be demonstrating the Redifon GR400 single sideband radio-telephone equipment at the meeting of the Sutton and Cheam Radio Society on November 17th. The meeting will be held at 8.0 at "The Harrow," Cheam Village.

Cleckheaton.—At the November 11th meeting of the Spen Valley Amateur Radio Society a member of the staff of the B.B.C. Holme Moss television station will talk about Z Matching. On the 25th the subject "Printed circuits" will be dealt with by a representative of Mains Radio Gramophones. Meetings are held at 7.30 at the George Hotel.

Derby.—Perspex and its uses for the amateur will be discussed by A. Hitchcock (G3ESB) in a talk to the Derby and District Amateur Radio Society at 7.30 on November 4th in Room 4, 119 Green Lane.

Dorking.—"Amateur radio in America" is the title of the talk to be given by C. Crook (G5BT) to members of the Dorking and District Radio Society on October 27th. Meetings are held on the second and fourth Tuesdays of each month at 8.0 at the Star and Garter Hotel.

Leeds.—At the meeting of the Leeds Amateur Radio Society on October 21st W. Ripley will discuss the building of a simple short-wave superhet receiver which he will demonstrate at the meeting on November 18th. On November 4th a stereo demonstration will be given by J. R. Hey. Meetings are held at 7.45 at Swarthmore Educational Centre, 4, Woodhouse Square, Leeds, 3.

The National Radio Show— In Retrospect

ANALYSIS OF TRENDS SEEN AT EARLS COURT BY "WIRELESS WORLD" STAFF

AERIALS

MANY factors influence aerial design and practice, e.g., the increasing number of transmitters (i.e., better coverage), improvements in receiver design and, last but by no means least, cost of production and erection. One comparatively recent outcome has been the small set-top "V" which the customer himself fits and adjusts. This configuration of elements is in itself interesting; because the resistive component of the feed impedance can be varied over quite wide limits by varying the angle included between the elements and the reactive component is changed by varying element lengths. By this means some sort of fairly-effective transfer of energy to the receiver input circuits can be achieved; but these small aerials are limited in scope mainly by their low "gain" even when placed in the best position to take advantage of the standing-wave pattern in the room. Improvements in receiver gain and noise factor help, and the last few years have seen some remarkable achievements: for instance Murphy quote for their new television receivers a gain of 16 times that of the equivalent 1955 models. However, another approach is to increase the "gain" of the aerial whilst retaining its "over-the-counter sale" character. An example of this was the Belling-Lee "Metropolitan" which has elements adjustable both for length (extending to about 40in compared with the 18in or so of the smaller aerials) and included angle. The base contains a centre-loading matching network which can be adjusted by a built-in switch and the smallest coils are printed with the switch contacts whilst the larger inductors are of self-supporting construction.

Matching, in various forms, has received a fair amount of attention; the X-aerial, for instance, has a feed impedance which may be as low as 20Ω , and the direct connection of this to an 80Ω feeder can result in a loss of gain or even a degradation of the directional characteristics. As the X-aerial is usually used because it has a good front-to-back ratio this latter point is particularly important. Several years ago Wolsey added a λ match (in basic form a pair of divergent bars connecting the feeder to an unbroken element) to their X aerial, calling it the Deltex, and Aerialite used folded elements (Dublex). Both these firms have changed their designs now—Wolsey (Model X75) retain the λ -match section; but they have added a small (30-pF) ceramic capacitor in series with the coaxial cable "inner", so that the result resembles a marriage between the λ and γ matches. (The γ match uses a feed rod parallel to the element and connected to it through a series capacitor.)

Labgear, in their new range of combined Band-I-X/III-Yagi arrays, have a more recognisable form

of γ match, the capacitive coupling being formed by a length of coaxial-cable inner pushed up inside the γ -match section. This also forms an unbalance-to-balance transformer and the Band-III section of the aerial can be mounted to receive transmissions of the same polarization as the Band-I aerial, or those at 90° to it. Aerialite have abandoned folded elements as a means of raising the feed impedance and have substituted instead a quarter-wave transformer of 35Ω coaxial cable. Another modified form of λ -match was noted on the J-Beam "Omnislot"; this is a medium-gain (6 to 8.5dB) slot array covering all Band-III channels (6 to 13 inclusive).

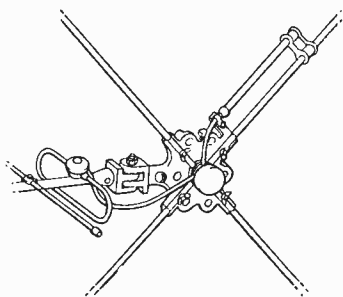

Detail of Labgear γ -match section on X-aerials. Resonant line connects Band-III Yagi to Band-I "X"

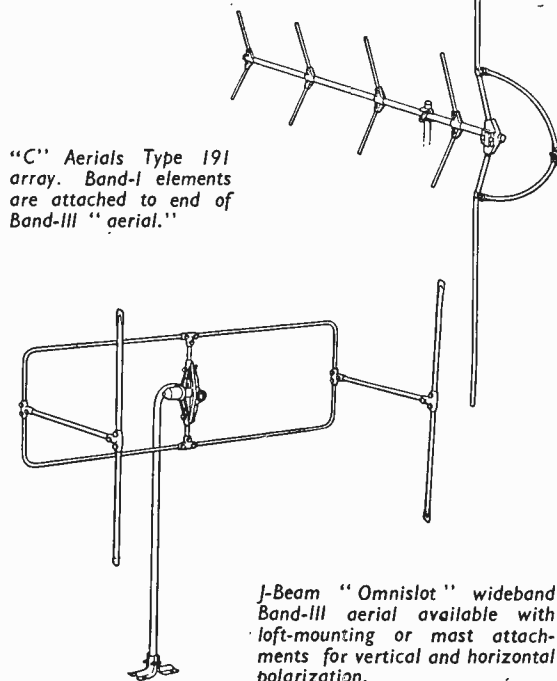

J-Beam "Omnislot" wideband Band-III aerial available with loft-mounting or mast attachments for vertical and horizontal polarization.

A newcomer to the Radio Show—"C" Aerials Ltd.—were showing Band III and Band II arrays, which one visitor described—rather uncharitably—as looking like emaciated kippers; however, there can be little doubt that something very interesting has been developed. In place of the customary folded dipole is a construction which resembles a simple dipole, which is bent towards the transmitter, with an electrically continuous "C" added at the "back." Some independently obtained test results for a *prototype* 6-element array showed a gain of $5\frac{1}{2}$ to $7\frac{1}{2}$ dB over the whole of Band III. It is claimed that the performance has since been increased considerably by careful attention to the first (i.e. next to the dipole) director, so that the gain on one channel is as high as 12dB. Another advantage claimed for the aerial is the small number and amplitude of subsidiary lobes.

Combined Band-I/III aerials have been with us since the start of I.T.A. transmissions, but now that two Band-III stations can be received in some areas, the form of these aerials is likely to change. Wide-band Band I/III aerials were shown first three years ago (J-Beam). Last year Labgear were showing a wide-band V and J-Beam's new aerial this year was the "Omnislot" (mentioned above); but none of these provides for Band-III stations which are not co-sited. However, a new approach by Labgear consisted of a typical in-line Band-I/III combined array with another set of Band III directors, of independently adjustable line-of-fire (see picture p. 378, September issue). It might be thought that re-

radiation of either Band-III signal by the parasitic elements "not in use" would be a problem; however, it is claimed that, by making each set of directors of comparatively narrow bandwidth, the loss of signal is fairly small. Whilst on the subject of combined aerials it is worth noting that Aerialite have produced a small printed-circuit diplexer to replace their tuned-line "Crosslink" interconnection between Band-I and III sections. This is moulded into the feeder-connection block for protection from the weather.

Mechanically, little change from the continuous trend of simpler and quicker erection was noted. Aerialite have standardized all their fittings so that they are interchangeable, and Belling-Lee have introduced a new range of loft aerials using tubular booms and well-nigh indestructible plastics element clips. Another improvement came from Antiference, who were showing a new snap-erection element clip. This, called the "Rota-Click," is particularly ingenious in that it avoids the need for splitting the "end-of-boom" elements for packing; but allows them to be fitted to the boom at the factory. To avoid the danger of mechanical damage whilst the aerial is in its pack, all the elements lie along the boom, and the end elements are pushed through the clips so that they do not project beyond the end of the boom. To assemble the aerial it is necessary only to push the end elements through their clips until the pip in the centre of the element locates the hole in the clip; then each element is given a quarter turn so that the spigots on the clips drop into the holes in the circular pressing.

Accessories.—To obtain adequate separation in a diplexer between two Band-III signals one or two channels apart is no mean feat, and to combine this facility with a Band-I pass characteristic on one channel produces an accessory which will probably be in great demand in areas where two Band-III transmitters can be received. Actual circuit details of Labgear's diplexer were not available; but individually tuned circuits are employed, using four trimmers, two fixed capacitors and five inductors. Separation is claimed to be 15dB for one-channel spacing, 20dB for two, and the pass-band insertion loss is less than 1dB.

Distribution equipment is obviously growing in importance and two new items were shown by Wolsey and Belling-Lee. Belling-Lee's new amplifier Type L1454 takes the form of a case containing

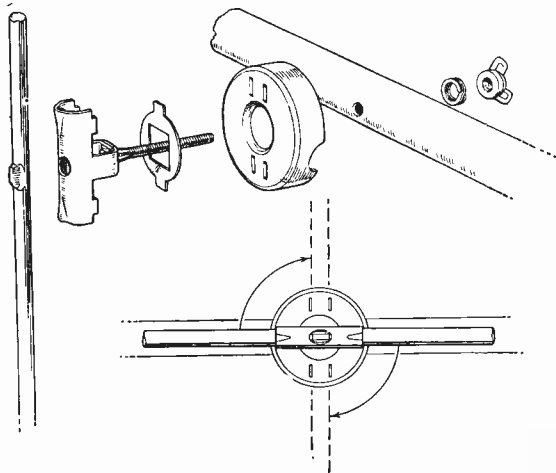

"Rota-click" snap-erection device (Antiference). Aerial can be folded for repacking by loosening wingnut.

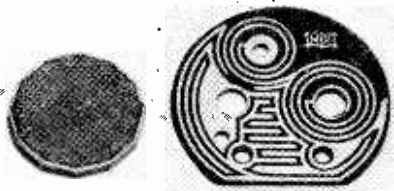

Printed-circuit diplexer panel for moulding into connector block (Aerialite).

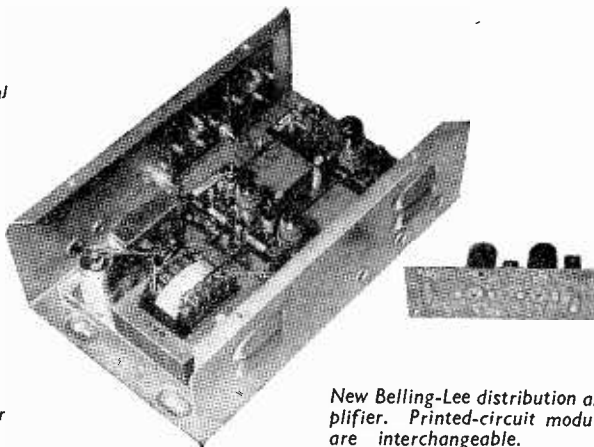

New Belling-Lee distribution amplifier. Printed-circuit modules are interchangeable.

a power unit and two triplexers: into this case can be fitted three "modules" on printed-circuit panels. These modules have a gain of more than 22dB on any one channel (or the whole of Band II) and they are secured by four screws—two contacting earth and the other two h.t. and l.t. supplies. Pentodes are used in all units—a single EF80-type for Band I and two EF95s for Band II and Band III. Any combination of modules may be used, and a lower noise factor is claimed than that of the previous cascode amplifiers!

To avoid cable loss at high frequencies, a quite-common practice is to convert the Band-III signal to a "vacant" Band-I channel for distribution. To do this Wolsey have added to their range of ampli-

fiers a "channel translator," which is a small unit in circuitry not unlike a receiver "front end"; but without the coil turret.

E.M.I. Sales and Service have developed a distribution system for both television and v.h.f./f.m. in which all the services available in a given district are translated into convenient channel frequencies and then passed through wide-band distributed amplifiers and coaxial lines to subscribers. Instead of the usual resistive attenuator pads designed to prevent mutual interference between receivers, directional couplers formed from a length of cable and a matching resistor are used in the E.M.I. system. These give a subscriber-to-subscriber loss of 56 to 62dB for a cable-to-subscriber loss of only 10 to 16dB.

TELEVISION RECEIVERS

THIS year saw the wholesale introduction of television sets with the new 110° short-neck cathode-ray tube. Almost every manufacturer had examples on show and the general effect of shallow-depth "slim" cabinets was very noticeable. The new tubes are in two sizes, 17-inch and 21-inch. With the 17-inch a reduction in cabinet depth of about 3 inches is possible over a set using an equivalent 90° tube. With the 21-inch a reduction of about 5 inches can be obtained. In fact, the average 17-inch set seems to be about 13 inches from front to back and the 21-inch set about 16 inches.

The measurement of maximum depth at the centre line is not really important, however, because various tricks are employed to make the cabinets appear thinner than they really are, and these tend to obscure the actual dimensions. In many sets, particularly the 17-inch portables, the sides are made only about 6-9 inches deep and the rest is taken up in a discreetly bulging back cover. This technique is genuinely useful in reducing bulk where the receiver is placed across the corner of a room, and it has been exploited to the full in the Philco "picture-on-the-wall" set illustrated last month (p. 380).

An alternative technique, of making the tube face project at the front, while still keeping the sides narrow, was introduced last year in the form of "picture frame" presentation. This year the same general principle has been applied in a more subtle way to give bow-fronted cabinets. Where two front-facing loudspeakers have been placed on either side of the screen there is sufficient frontal area to allow a pleasant continuation of the tube-face curvature in the cabinet.

One of the slimmest receivers at the Show, a new Ekco portable, had an overall depth of under 12 inches. This is made possible by the use of a new shorter-than-normal 110° c.r. tube, the 17-inch CME1705, just introduced by Siemens Ediswan. The short neck of this tube is achieved by a new design of electron gun and by mounting this gun as near to the deflection coils as possible without affecting focus quality and reducing deflection sensitivity too much. (Focus deterioration can occur if the beam is deflected off centre inside the electron lens system; loss of deflection sensitivity if the focusing action works against the deflection field.) As a result the tube has an overall length of

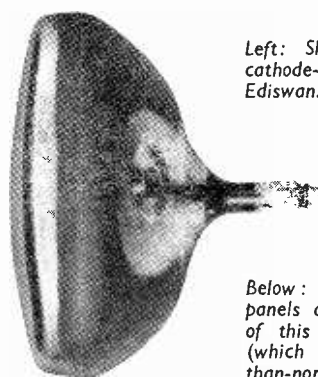

Left: Shorter-than-normal 110° cathode-ray tube made by Siemens Ediswan.

Below: Hinged printed-circuit panels are used on the chassis of this new Ekco portable (which has the above shorter-than-normal 110° tube).

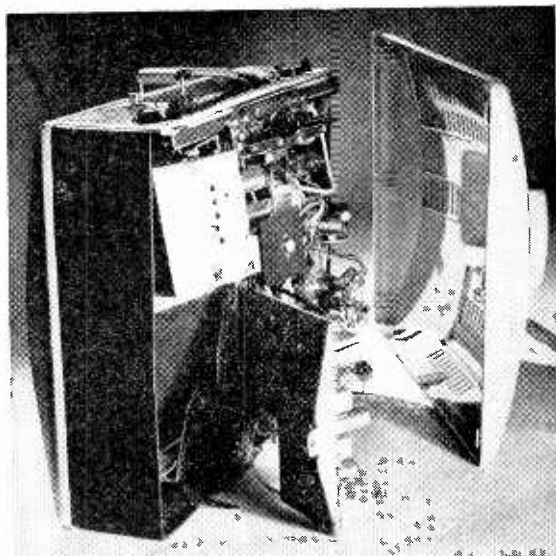

11½ inches, which is 1¼ inches shorter than the normal 17-inch 110° tube made by this firm.

Whereas the normal 110° tube uses a standard tetrode electrostatic-focus gun, as shown in Fig. 1 (a), in which the main focusing occurs at a "break" in the long final anode cylinder, the new version has a three-potential lens arrangement as shown at

(b). Here the acceleration and focusing of the beam take place simultaneously, so that a shorter length of gun is achieved. Cathode, grid and first anode follow normal practice. The main focusing lens, however, is formed by interposing the low-voltage cylinder A_2 between the first and final anodes. This effectively carries out the whole focusing action in what corresponds to the "pre-focus" region of the normal tetrode gun at (a).

With 110° sets in general, the widening of the scanning angle from 90° —just over 20%—would normally call for an increase of scanning power of about 50%, since the power required is proportional to the square of the deflection angle. Some of the ways in which this problem has been tackled have already been discussed in *Wireless World**. Part of the extra power requirement is offset by the narrower neck of the 110° tube, as explained. Another part is provided by line and frame output transformers of increased efficiency (improved ferrite core materials being used for the line output). There are not, in fact, any startling changes in the actual circuitry of the scanning generators, and the familiar PL81 line output pentode is still being used extensively in the new sets.

In R.G.D. and Regentone 110° receivers, extra scanning power is provided by raising the h.t. line voltage, and this is achieved by the interesting development of using silicon diode power rectifiers instead of thermionic or metal types. It means in practice that the current requirements of the scanning valves are not any greater than those for 90° deflection circuits. Higher h.t. voltage is obtained by virtue of the fact that the silicon junction rectifier is a higher efficiency device, with a very low forward resistance compared with that of the valve or metal rectifier. The h.t. line voltage of the receivers is, in fact, 230 volts, and the d.c. is provided by two S.T.C. silicon diodes in series, working half-wave into a $100\mu\text{F}$ reservoir capacitor, a 0.5H choke and a $400\mu\text{F}$ smoothing capacitor. Because of the small power dissipation in the silicon diodes they run very cool and this helps to keep down the general heat, which is something of a problem with the close packing of components in modern sets. The small size of the rectifiers helps to save space as well.

For efficient operation of the line output stage in wide-angle deflection circuits it is desirable that the working point of the valve should be stabilized against mains fluctuations, ageing of the valve and other such variations. If the peak voltages in the stage are stabilized it is possible to run the valve much closer to its limiting values without danger. One quite simple stabilizing circuit appeared in the line output stage of the Ferguson "500" series of 110° receivers. The essentials of this are shown in Fig. 2. It is basically an a.g.c. system which controls the gain of the PL81 output valve so as to maintain the flyback pulse at a constant amplitude. Since the flyback pulse depends on the current flowing through the line scanning coils then this scanning current waveform is also maintained at a constant amplitude.

The grid, and thereby the gain, of the PL81 is controlled by a voltage across a voltage-dependent resistor derived from the average value of the flyback pulse waveform (through capacitor C_1 from a connection on the line output transformer). The working point on the grid base of the valve is set by

* "110° Scanning," January, 1959, issue.

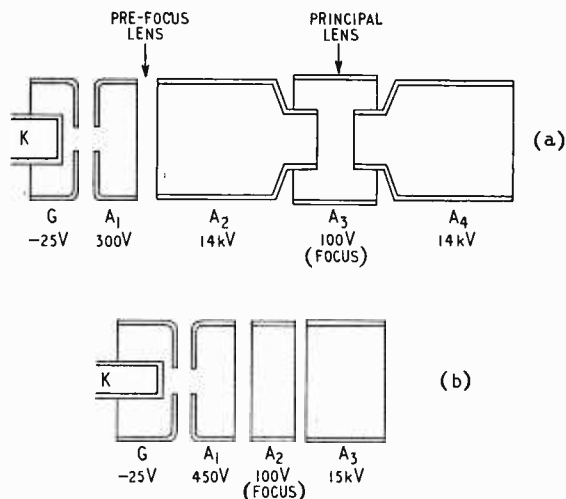

Fig. 1. Comparison of the normal tetrode gun (a) with the new shorter tri-potential gun (b) of Siemens Ediswan 110° cathode-ray tubes.

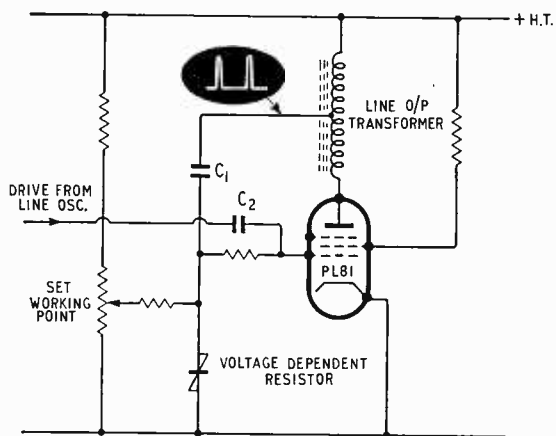

Fig. 2. Automatic stabilization circuit for line output stage on Ferguson receivers.

the d.c. potentiometer arrangement fed from the h.t. supply, while the coupling capacitor C_2 acts as a reservoir to convert the pulse waveform to a direct voltage. If the voltage-dependent resistor were a linear resistor the average value of the flyback waveform applied to the grid would be zero. But because of the non-linear characteristic of the voltage-dependent resistor, which gives a rectifying action, the average value as applied to the grid is slightly negative (i.e. the pulse waveform becomes distorted so that the positive side is decreased and the negative side is increased).

When some fluctuation causes, say, an increase in the flyback pulse amplitude, the negative control voltage is increased (but more than proportionately, owing to the non-linearity of the voltage dependent resistor), so that the gain of the PL81 is reduced and the flyback pulse amplitude is brought back to normal. Conversely, for a fluctuation in the other direction, the negative control voltage is reduced and the valve gain is increased.

Another development aiming to conserve power in the scanning system was a new type of picture

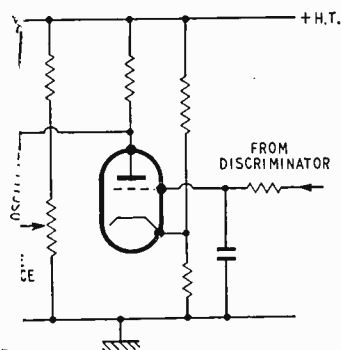

Fig. 3. Automatic frequency control circuit using a point contact diode, for operation on v.h.f./f.m. sound (Murphy).

centring device for the cathode-ray tube, demonstrated privately by Mullard. It was based on the familiar ring-shaped magnets, but instead of using metal rings it had plastic rings incorporating Magnadur magnetic material. These were magnetically polarized across diameters in the usual way.

The advantages of the plastic material are that it avoids eddy-current losses on the line scanning coils and avoids magnetic shorting of the frame coils (which is an important consideration with the greater fringe field produced by toroidal frame coils). As a result of the lack of shunting on the coils it is possible to place the plastic magnets closer to the centre of deflection and so reduce geometric distortion of the raster. (Such distortion occurs when the electron beam does not pass through the centre of the scanning coil assembly.) Mullard also had a smaller and lighter Ferroxcube core for scanning coils—a particular advantage in transportable receivers.

At the signal-frequency end of the set, the frame-grid type of r.f. amplifier valve is now being used extensively and making possible higher sensitivity receivers. This is particularly important with the transportable type of sets, which have to work from small indoor aerials. The majority of receivers use turret tuners, although Pye still favour the incremental inductance type and Bush the permeability type in their latest receivers. (Incidentally, Bush have extended their push-button station selector, introduced last year, to more models this year.)

A large proportion of new sets contain facilities for reception of v.h.f. sound programmes, so the early objection to this scheme—that the viewing public must have the medium-wave Radio Luxembourg amongst its sound programmes—cannot be valid any longer. Perhaps the I.T.A. has now more than satisfied this need. Even so, one manufacturer (Emerson) with the originality appropriate to a new boy at the Radio Show, was exhibiting a 17-inch 110° set which incorporated a Radio Luxembourg attachment—a two-valve a.m. tuner, in fact. The ferrite rod aerial could be orientated by a control at the back of the set.

Some of the receivers providing the v.h.f./f.m. sound facility still use the 38-Mc/s television intermediate frequency, with, in certain cases, the addition of an extra i.f. stage to improve the gain on f.m. The problems of selectivity with such a technique are well known, and a good many of the new sets provide for a 10.7-Mc/s i.f. when switched to v.h.f. sound. The valves in the i.f. amplifier sec-

tion have two i.f. transformers in series in their anode circuits, one tuned for the 38-Mc/s i.f. and one for the 10.7-Mc/s i.f. When the set is switched to the higher frequency for television, the 10.7 Mc/s transformer is shunted by its tuning capacitor, which appears as a low reactance and so does not affect the operation of the amplifier. When switched to 10.7 Mc/s for v.h.f. sound, the 38-Mc/s transformer appears as a low inductive reactance which again does not affect the operation of the amplifier.

With the narrower bandwidth of the v.h.f. sound circuits the stability of the local oscillator becomes a problem. Some receivers compensate for drift by means of negative-temperature-coefficient capacitors connected across the tuner coils. In the latest Murphy television receivers, however, an interesting a.f.c. circuit is provided for use on v.h.f. sound (appropriately, from a firm which pioneered a.f.c. in sound receivers in the 1930s). This makes use of a point-contact germanium diode as a variable capacitance device, connected as part of the oscillator tuning capacitance. It does not, however, work in the same manner as the well known reverse-biased junction-diode variable capacitance system. The capacitance of the point diode varies from about 1.5pF to about 2pF with an increase of the forward (rectification) current passed through it. This current is supplied by a one-valve d.c. amplifier, as shown in Fig. 3, which in turn receives a control signal from the f.m. discriminator (a balanced ratio detector).

When the receiver is correctly tuned there is no d.c. "error signal" from the discriminator. If the oscillator should drift in the direction of increasing frequency, a negative voltage from the discriminator causes a positive rise at the anode of the d.c. amplifier. This causes the forward current through the point contact diode to rise and its capacitance is increased, thereby lowering the oscillator frequency and bringing it back to normal. Conversely, a drift in the other direction produces a decrease in the diode capacitance and an opposite frequency correction. The potentiometer arrangement in Fig. 3 is for back biasing the diode so that it normally passes a forward current of about 300µA. Capacitor C is merely to isolate the oscillator from the direct voltage applied to the diode.

Incidentally, the new Murphy receivers still use the double superheterodyne principle described last year† to obtain the necessary selectivity. Instead of last year's four-position turret they now have a seven-position turret with separate positions for the Home, Light and Third programmes on v.h.f. sound. With the a.f.c. system no continuous tuning is required for sound, as was provided before.

Several new devices relating to picture quality were noted this year. All the latest receivers in the Pam range have been fitted with Polaroid filters in front of the screen to eliminate reflections of light sources and other brightly lit objects in the room. The picture contrast is improved as well, by elimination of reflection from the general room illumination. In these filters the light from the room passes first through a layer of material which allows only the waves polarized in one direction to be transmitted. These waves then pass through a "quarter-wave retardation sheet" (bonded to the first layer) which rotates their polarization by 45°

† *Wireless World*, October, 1958, p. 477.

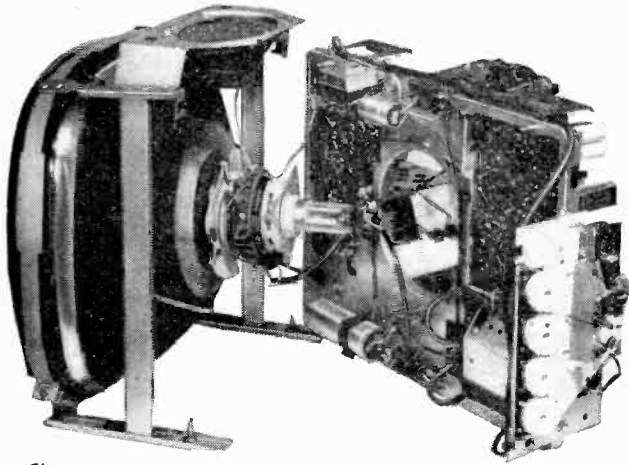

Clip-on chassis system in Sobell receivers to give accessibility for servicing.

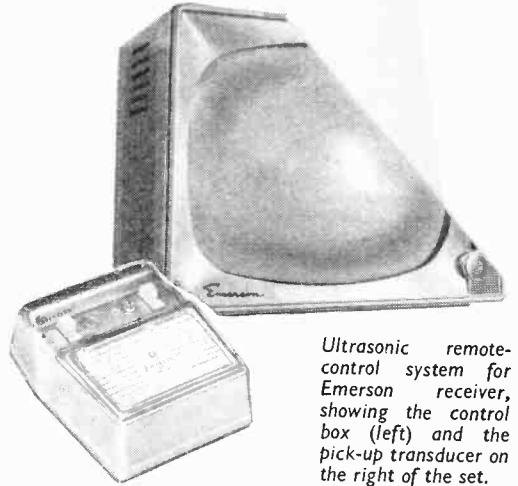

Ultrasonic remote-control system for Emerson receiver, showing the control box (left) and the pick-up transducer on the right of the set.

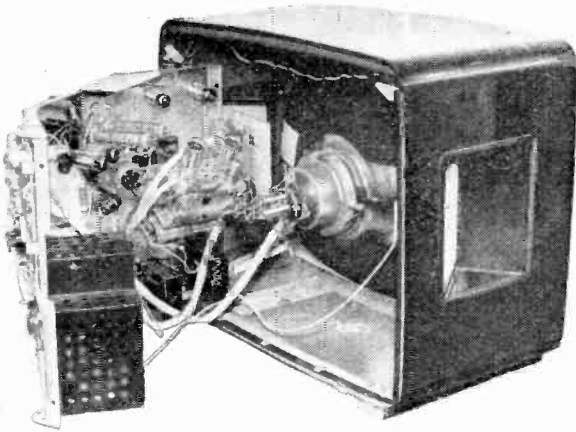

Hinged chassis in a Philips set, swung out to give access to all the circuitry.

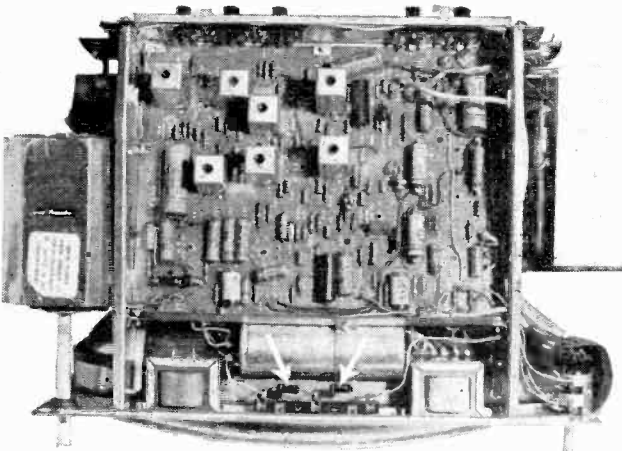

Underneath view of the horizontal printed-circuit chassis of R.G.D. and Regentone sets. The valves are on the other side. The silicon diode h.t. rectifiers are arrowed.

before they strike the tube face. After reflection from the tube face the light passes back through the quarter-wave sheet which rotates the polarization another 45° , so that the waves are now at 90° to the direction they were originally given by the polarizing layer. Consequently they have the wrong direction of polarization for passing back through the layer, and the layer blocks the reflected light (or, at least, 98-99% of it, according to claims) from the eye of the viewer. Since the reflected room light is virtually eliminated in this way while the light generated by the cathode-ray tube is merely polarized, giving only a slight reduction, the net result is an improvement in picture contrast. Unfortunately, a demonstration of the filter using two receivers, one with it and one without, was marred (at least when we saw it) by unequal settings of picture contrast, but the principle seems quite sound nevertheless.

Automatic systems for adjusting picture contrast in accordance with the strength of the room lighting are a feature of many Continental receivers, as reported in our last issue (p. 404).

None was seen in television sets at Earls Court, but Mullard privately demonstrated two methods using light-dependent resistors as the pick-up devices. In one, the light-dependent resistor is incorporated in the vision a.g.c. network of the set. This has the advantage that the pick-up device is used in d.c. circuits, so that the layout and length of leads are not critical. Moreover, the a.g.c. delay prevents the system from functioning on very weak signals, so that the full gain of the receiver is used. In the other method, the light-dependent resistor forms part of an attenuator network between the video amplifier and the c.r. tube. This has the advantages that the automatic contrast control is independent of the vision a.g.c. and that the sound signal amplitude is not affected (as it might be with the first method).

Picture "crispening" and "softening" were provided by push-button controls on one of the new Stella receivers. The "crispening" is achieved by

switching a CR filter network into the cathode circuit of the video output stage. This reduces the amplitude of the lower and middle frequencies and induces the video circuit to "ring" at the higher frequencies, thereby accentuating edges in the picture and giving the effect of an apparent increase in definition. The "softness" effect is achieved by limiting the highlights of the picture in much the same way as an interference limiter cuts off the white spots caused by ignition interference. In fact, the "soft" push-button switches a negative bias voltage to the suppressor grid of the video output valve which over-rides the negative bias already applied by an interference-limiter potentiometer. These negative biases set a limit to the maximum peak anode current so that interference pulses or video-signal peaks (according to the switching) saturate the valve and the intense whites do not appear on the screen.

Remote control of television sets from the armchair seems to be advancing in America, where already automobiles have atrophied the leg muscles and now television is completing the job by atrophying the will to use them. One example which has crossed the Atlantic, and was demonstrated at Earls Court, is the Emerson ultrasonic remote control system. The small armchair control box (see picture) contains a battery-powered transistor oscillator, for working at two frequencies in the region of 40kc/s, and a transmitting crystal transducer. On the television set another crystal transducer picks up the ultrasonic waves from the control box, and a frequency detector determines which of the two frequencies is being transmitted. One frequency is

used for controlling the station selector (by means of a stepping-motor drive system in the receiver) and the other for muting the sound output from the loudspeaker. Psychological note: there is no armchair provision for *switching off* the set.

Turning to mechanical matters, great emphasis was placed this year on the design of chassis for ease of servicing, and many firms displayed the insides of their sets to show just how well they had done. This problem of accessibility is particularly acute with the short-neck 110° tube, because a very close packing of components behind the bulb is necessary to preserve the slimness of cabinet which the tube makes possible.

Most sets have a vertical chassis, with the tube neck passing through a gap in the centre. Some designs have the chassis on hinges so that it can be swung sideways or upwards away from the tube assembly. Others have a chassis which clips on and off. Still others leave the main chassis frame fixed and provide a number of small printed-circuit sub-chassis which are either hinged or can be detached completely.

In the latest R.G.D. and Regentone models however, there was a reversion to the old idea of a horizontal chassis. In keeping with modern trends, it was a printed-circuit chassis, but it had the important difference that the valves were on the *opposite* side of the board to the components (valves on top and components below). This avoids the usual congestion of valves and coil screening cans which often makes it difficult to gain access to the components and their connections on a printed-circuit board.

SOUND RECEIVERS AND REPRODUCERS

Valve Receivers.—With major improvements in the valves themselves rather unlikely, developments in the field of valve receivers depend mainly on changes in programme transmission systems. With the last major development in transmission—v.h.f./f.m.—now some five years old, and the next—we would guess stereo transmissions—still some time to come, one would thus expect few radically new developments in the field of valve receivers, and this expectation continues to be borne out.

One change, however, was an increase in the number of f.m.-only receivers, so that these are now available from most of the major manufacturers and are no longer the rarity they have been in previous years. Such receivers cost only about £15.

A reflection of the increasing interest in tape recording is the now fairly common provision of an output socket for feeding a tape recorder. Although in some cases this socket was connected to the secondary of the receiver output transformer, in most cases it was connected prior to the output stage. This latter connection is preferable since it bypasses the output stage and transformer distortion which usually makes up by far the greater part of the total receiver audio amplifier distortion.

One new styling trend is the increasing number of "long low" shaped cabinets: another styling trend—the provision of edge-on control knobs—while already familiar in the field of television, is new to sound receivers.

Transistor Receivers.—In addition to the obvious

use of transistors in making very small receivers, we noted last year a trend towards providing transistor receivers to correspond to ordinary valve battery receivers in size as well as sound output and quality. This trend has already involved the use of larger loudspeakers and push-pull output stages, and continues this year with an increase in the maximum available output power to about one watt. The Murphy B385 can be used as either of the two types of transistor receiver, for the basic receiver unit may

Murphy B385 transistor basic receiver unit (centre) with alternative "neo-hide" (left) and wooden (back right) cabinets.

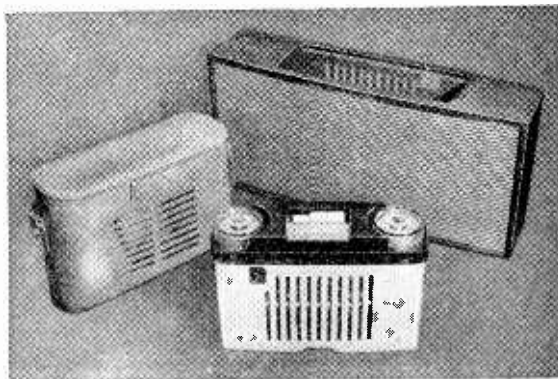

be placed in either a small "neo-hide" carrying case or alternatively, together with larger batteries, in a wooden table cabinet.

Sockets for connection to a car aerial to avoid changes in the signal input level from the directional internal aerial as the car heading alters were already provided last year by Perdio, and this year were incorporated in nearly all transistor receivers. In some cases the tuning scale was fitted at the top of the cabinet and this made a suitable size and shape to fit conveniently in the glove compartment of the car.

Most receivers now also provide full coverage of the long-wave band rather than the restriction to the switched reception on long waves of only the B.B.C. light programme, noted in some models last year.

Two receivers—the Pye "Cruiser" and Perdio "Continental"—now also cover the 80 to 190 metre

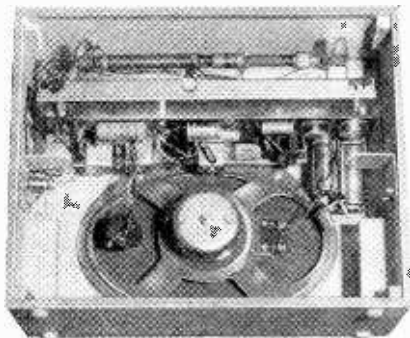

Perdio "Continental" transistor receiver using large output transistors and speaker.

"trawler" band. In the latter receiver the relatively high oscillator frequencies required are provided by the second harmonic of the OC44 oscillator.

The Perdio "Continental" is also interesting in that its r.f. bandwidth is automatically broadened if the signal strength increases—thus providing the maximum possible bandwidth for a given signal-to-noise ratio. This is achieved by feeding the detected signal voltage to a diode across the first i.f. coil to produce increased damping of this coil at higher signal voltages. This receiver also follows the trend of providing better quality audio by having a relatively high maximum output power of 1 watt and using a speaker as large as 8in by 5in.

Some guide as to things to come was given by the Mullard research laboratories private exhibits for set manufacturers. For covering short wavebands up to 26Mc/s frequency changers were shown using either two OC170's as a mixed and separate oscillator, or a single OC170 as a self-oscillating mixer. The latter system is of course more economical, but has a lower gain, higher noise, and is more likely to produce spurious responses than the former. With this

single OC170 system the second harmonic component of the oscillator output is used to cover the 12 to 26Mc/s band. An experimental a.m./f.m. transistor receiver using five r.f. and four a.f. transistors was also shown. The individual transistor functions follow rather closely their usual counterparts in a valve a.m./f.m. receiver except that in the transistor receiver there is an extra i.f. stage and a push-pull rather than a single-ended output stage is provided.

Stereophonic Record Reproducers.—Among the larger models the trend is towards placing all the equipment in a single cabinet, while among small models more examples were seen of the economical technique of making the lid detachable and using it as a baffle for one or (with a split lid) both loudspeakers. In general though, the wide variety of loudspeaker arrangements noted last year persists.

With single-cabinet stereo radio-grams the loudspeakers were nearly always positioned either at the ends facing forwards, or alternatively, at the sides facing sideways.

When only a single cabinet is used, the overall apparent sound field is generally restricted to the necessarily fairly small width (up to 5ft say) of this cabinet. For extending the sound field beyond the cabinet, most models provide for the use of separate extension speakers.

Two other methods of extending the sound field of a single cabinet were noted in the E.A.R. model 500 and Defiant AF9 radio-gram. In the latter case, the loudspeakers face sideways on to reflecting panels hinged about the back corners of the cabinet so as to provide wider-spaced forward-facing apparent sound sources behind these panels. In the E.A.R. model 500, sideways facing speaker enclosures are provided which can be hinged about the front corners of the cabinet to actually increase the spacing between the loudspeaker sound sources. Alternatively, this spacing can be increased still further in this model by detaching the loudspeaker enclosures altogether from the main cabinet.

To provide the direct sound which Decca feel is desirable to secure a good stereo effect at almost any point in front of their new Decola, they have used as
(Continued on page 445)

Stereo "Decola" showing two sets of six tweeters angled in various horizontal and vertical directions to give direct sound at most listening positions in front of the cabinet.

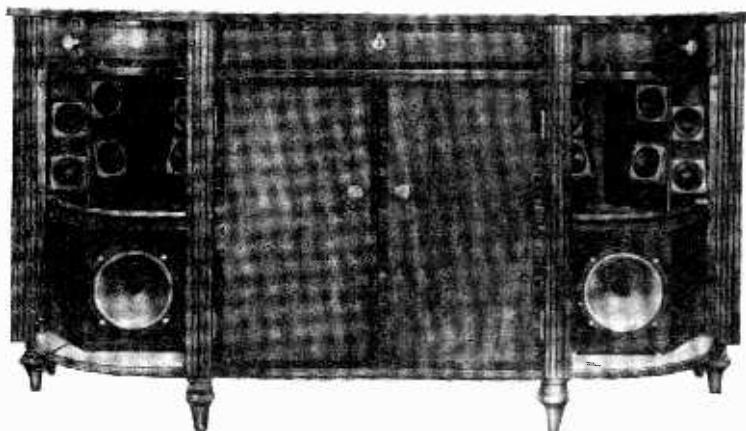

many as 6 tweeters for each stereo channel angled in one of 2 vertical or 3 horizontal directions. This model incorporates the Decca variable-reluctance stereo pickup.

One difference from last year which we noted was a considerable increase in the number of combined single-channel amplifier and speaker units for converting single-channel equipment to stereo.

The advent of stereo seems to have stimulated a desire for better-quality sound and control refinements, so that one now quite often finds such features as bass as well as the usual treble controls, balance controls, diamond styli, reflex loading and separate speakers for the treble and bass, even for example in relatively inexpensive stereo radio-grams where one would have expected the necessary complexities of stereo to absorb all the available finances. This trend was also observed in single-channel equipment.

An unusual and ingenious single-amplifier stereo "phantom" system was seen in the Emerson 502A record reproducer. In this system the two stereo channels are fed out-of-phase one to each of the two output valves which are connected as in a normal push-pull amplifier. These valves then act simultaneously both in push-pull in a normal transformer for the sum of the two channels, as well as in parallel for the difference between the two channels in an additional single-ended transformer which is connected between the centre-tap of the push-pull transformer and the h.t. supply. The total power available with this arrangement is nearly double that from the two valves operated separately single-ended. This type of circuit was more fully described in the "Technical Notebook" section of this journal for February 1959 (p. 80).

When single-ended amplifiers are used for the two stereo channels these are generally operated simply in parallel for single-channel reproduction. In Ferguson, H.M.V., and Marconiphone stereo radio-grams, however, they are connected in push-pull for single-channel radio reproduction, and at the same time the valve operating conditions are changed from class A to class AB. The net result is a higher total power output because of the change from class A to class AB, and reduced distortion because of the change from single-ended to push-pull. Moreover, the output stage current consumption is also reduced. This allows economies to be made in the mains transformer and rectifier which more than pay for the extra switching involved.

Another interesting feature of these Ferguson, H.M.V., and Marconiphone radio-grams is the use of a conveniently non-linear balance control so that, if the control knob is uniformly rotated, the rate of change produced is at first small to allow exact balancing in the usual case of circuits of nearly equal sensitivity, and then, as the knob is rotated further, the rate of change produced is much larger to allow balancing of circuits of widely-differing sensitivities.

A number of convenient additional facilities were noted. For example, in the Ekco model RP343 and Ferranti model RP1022 record reproducers in which two separate volume controls are used, a mute button is provided so that the sound can be silenced without disturbing both volume controls and thus also the balance. A useful facility in stereo systems in which the two cabinets are dissimilar was seen in several models. This was the provision of a stereo reverse switch to allow the two cabinets to be interchanged.

Where a loudspeaker is not in the same cabinet as its corresponding amplifier, arrangements must be made to ensure that this amplifier is not damaged if the speaker is disconnected. A simple method is to connect a jack socket to short the output transformer secondary if the plug is removed.



8. Brenell "Three Star" stereo recorder.

Tape Recorders.—Development in this field continues to be considerable. For example, the variety of tape decks used by manufacturers has been greatly increased by the recent introduction by B.S.R., Collaro and Garrard of new models. Both Trix and E.A.R. showed recorders using each of these decks.

One trend has been towards smaller sizes. This need not mean a reduction of playing time because of the recent introduction of double-play tape of half the standard thickness.

Another welcome trend has been in the direction of lower prices, several recorders now costing less than £30. A valve can be saved by using a single valve both as an erase oscillator on record as well as an audio output valve on replay. If the pentode part of an ECL82 triode-pentode is thus used, sufficient further gain can be obtained by using a single additional high-gain double-triode such as an ECC83. This two-valve arrangement was seen in recorders shown by Trix and Ferguson.

Several developments were also noted in the methods of determining the recording level. For example, the simple system of using two neon bulbs has previously been rather uncommon, but this year was seen on three recorders. In this method the two neons are arranged to strike at different levels so that, by adjusting the input level till the loudest sounds cause one neon to light but not the other, the peak recording level is restricted between two values. Restriction to within 10dB was provided in this way in a recorder shown by Alba, and to within 6dB in recorders shown by R.G.D. and Regentone (Mk 103).

Wide-angle sector EM71 magic eye recording level indicators were noted in tape recorders shown by REPS and R.G.D. (Mk 107). The wider sector angle allows more accurate measurement than with the familiar original sector magic eye, and the panel space taken up is less than with the recently introduced column-type indicators.

Stereo recording facilities are not very often provided even where stereo reproduction is possible. A recorder with this facility is the now well-established Reflectograph, and new models were introduced this year by Brenell (Three Star) and Veritone.

Stereo reproduction using separate heads with

their gaps staggered $1\frac{1}{8}$ -in apart was also demonstrated by Brenell using their Mark 5 deck (which has space for up to 4 heads). While crosstalk is almost eliminated by using separate heads, some trouble may be experienced in keeping the stagger distances sufficiently alike in different recorders to allow interchange of recordings.

To make the tape easier to handle the new Garrard deck incorporates a magazine. This contains two 4-in diameter reels so arranged that the tape is automatically placed in its correct position for playing, recording or rewinding by locating the magazine in its correct position on the tape deck. Correct magazine location is provided by tapered reel spindles and two raised ridges on the deck. Since lifting off and repositioning the magazine is so easy, fast rewind has been provided only in the forward direction. The supply spool runs on a friction pad to give correct tape tension. No pressure pads are used, the required close contact between the tape and head being produced by fingers which bear on the tape at either side of the record/replay head. The total wow and flutter is about 0.22% at the single tape speed provided ($3\frac{3}{4}$ in/sec). At this speed the record/replay head response can be extended up to 10kc/s by suitable equalization.

Unusual features were noted in two new recorders shown by Amplion. In their "Marine" recorder, operation from d.c. mains is possible using an internal 12-watt 50c/s oscillator incorporating four 6X4 valves in parallel push-pull. In their model A224 recorder, optional volume expansion of up to 6dB is possible using, in the prototype model, the standard method of connecting the output transformer secondary and loudspeaker across the two diagonals of a bridge consisting of two resistors and two lamps. The non-linear current/resistance characteristic of the lamps then provides the required expansion.

A professional portable stereo recorder shown by E.M.I. (the TR52) incorporates separate record and replay heads and amplifiers to allow monitoring of the signal recorded on the tape. Meter monitoring is possible of the signal in, signal out, record current, bias or erase on the sum of both channels or either separately.

Two sets of heads and tape tracking in both directions are used in the new R7 recorder shown by Truvox to allow both tape tracks to be played without having to turn the reels over. Other unusual features of this recorder are the provision of two alternative fast wind speeds to allow more accurate fast winding to a particular position on a tape, and the use of a linear slide type of volume control.

More emphasis than is usual on mechanical and thermal considerations is a feature of the range of REPS recorders. For example, mechanical noise is reduced by suspending the deck on rubber, and heating effects are minimized by the use of high-temperature lubricating grease and as many as five ventilation grilles. Electrical features include the use of humbucking coils to cancel the hum induced in the record/replay heads by the motors and mains transformer, and push-pull erase oscillators to eliminate d.c. components in the erase and bias waveforms and thus reduce tape noise.

A stereo head and twin pre-amplifier which can be clipped on the side of the Simon recorder to allow it to replay stereo tapes was recently introduced. **Tape Recording Accessories.**—Metro-Sound were showing a head cleaning fluid which is applied via

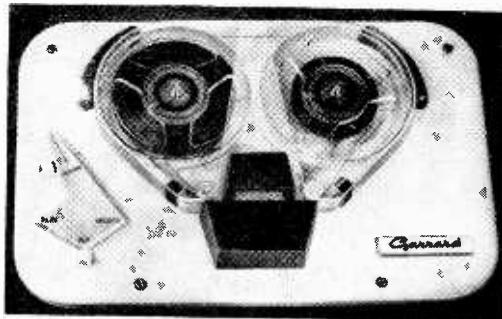

Garrard tape deck with magazine loading for ease of handling.

a special tape and also, for showing the position of a particular passage on the tape, small coloured strips called "Metro-tabs" which are folded over the edge of the tape and so dimensioned that they only obscure the indicated track. Tape Recorders (Electronics) were showing Sonocolor tape with black stripes across the back suitably spaced to provide a stroboscope for synchronization with film. Beam-Echo were showing a new range of stereo heads.

Stereo Microphones.—Like stereo tape recorders these, too, are rare. A twin ribbon model (VR65) has previously been shown by Lustraphone, and this year Cosmocord showed a twin crystal model. This contains two crystal pressure-differential figure-of-eight response inserts mounted at right angles to each other. The pressure-differential response results from cancellation effects obtained by mounting two ordinary crystals back-to-back. This cancellation also reduces the sensitivity by about 10dB and produces a frequency response rising at 6dB per octave which must be compensated for.

Loudspeakers.—An interesting sidelight of the action of the G.E.C. "Periphonic" enclosures is that the exceptionally heavy low-frequency loading produced on the loudspeaker cone tends to make this cone stay still so that the magnet moves. This tendency has now been eliminated in the G.E.C. metal cone speaker by means of a bracket round the magnet bolted to the speaker chassis. The result is an improved power-handling capacity below about 150c/s.

Two new single-cone full-range 10-in loudspeakers were introduced by Goodmans. Also introduced by this company was a horn-loaded tweeter in which the horn has been given an elliptical cross-section so that, by making the major axis vertical, a wide horizontal and narrow vertical response can be obtained, a requirement often advocated both for stereophonic and single-channel reproduction.

Gramophone Records.—A range of stereo records introduced by Saga is claimed to be compatible in that they can be played with an ordinary light tracking weight but low vertical compliance single-channel pickup without producing any deterioration in the stereophonic effect when using a stereo pickup. The special recording process involves, among other things, both a deeper recording cut and a wider groove spacing so as to produce a thicker groove wall. The recording time has been kept to the normal value of about 25 minutes per 12-in side by decreasing the groove spacing at low recorded amplitudes.

Pickup Cartridges.—An increase in the compliance

of the low tracking-weight crystal pickup described by J. Walton in our April issue now allows this cartridge to track at about 0.3gm. A prototype stereo version of this cartridge was also shown tracking at about 2gm.

Ceramic-element stereo cartridges were shown by Garrard and Electronic Reproducers. Compared with ordinary Rochelle salt crystals, ceramic elements offer lower dependence on temperature of the frequency response, higher possible operating temperatures and humidities, and a smaller size for the same output.

Electronic Reproducers also now manufacture in England under licence the German "Elac" range of variable-reluctance single-channel and moving-magnet stereo cartridges. The equivalent mass at the stylus tip of the stereo cartridges is about 2.3mgm.

Pickup Arms.—A prototype arm shown by Electronic Reproducers is unusual in that it uses a gimbal mounting. The gimbal pivots bear on a small rectangular metal block, the two vertical motion pivots being also attached to the arm and the two lateral to the pedestal. A weight counter-balance is used. The friction produced by this arm is claimed to be well below 0.2gm. It incorporates a raising and lowering device.

In the new inexpensive Cosmocord "Acopoise" arm the single axle lateral-motion pivot and the two cone and cup vertical-motion pivots have been placed nearly in line to minimize the side thrust produced by the pivot offset and an unlevel turntable (see J. Walton's article in our June issue).

Pre-amplifiers and Amplifiers.—One general trend seems to be towards combining these two units in a single chassis, even in the case of stereo equipment.

Unganged stereo bass and treble controls were used by a number of manufacturers. Avoidance of ganging facilitates balancing of dissimilar loudspeaker responses, and also allows a "pseudo-stereophonic" effect to be produced with single-

Acos stereo microphone.



Emisonic / Orthotone model 555 stereo combined comprehensive pre-amplifier/control unit and 2 x 10-watt amplifier.

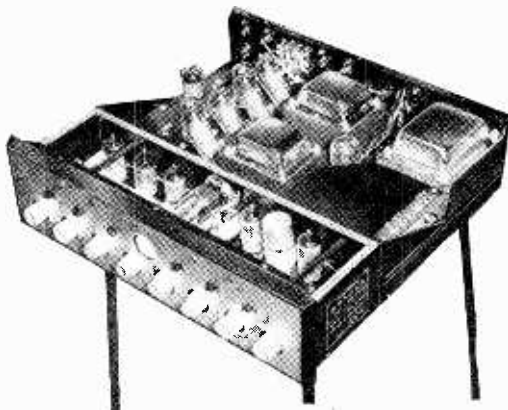

channel material by boosting the treble and cutting the bass to the left-hand speaker (to correspond to the frequency range of violins and their usual position in the orchestra) and cutting the treble and boosting the bass to the right-hand speaker (to correspond to the frequency range and position of cellos and basses). If the effects of these controls do not overlap or, as in the Tripletone units, a middle-frequency tone control is also provided so that middle frequencies can be fed to both speakers, then apparent sources may be produced in the middle as well as on the left and right, thus giving quite a convincing stereo effect.

New very comprehensive combined stereo tone controls and 2x10-watt amplifiers were shown by E.M.I. and Decca. Special features of the Decca FFSS "Stereo Sound" include a control for continuously altering the width of the overall sound field by introducing crosstalk between the two channels, and high and low-pass 18dB/octave filters whose cut-off frequency can be continuously varied. This amplifier also has an output impedance which below 400c/s can be varied between positive and negative values to apply the optimum damping to the loudspeaker voice coil in the frequency range in which rigid coupling also applies this damping to the loudspeaker cone. This enables the distortion produced by the loudspeaker at these low frequencies to be considerably reduced. This amplifier is also fitted with an optional bass-compensated volume (loudness) control for compensating for the alteration in the response of the ear at low frequencies to different sound intensity levels. The correct compensation for a particular intensity level is applied by adjusting a separate ordinary non-compensated volume control until the sound is either very quiet, quiet, loud or very loud, according to the position of the loudness control. Special features of the Emisonic/Orthotone 555 include the use of a 1-in. c.r.t. on which rectified signals from the two channels are backed off against each other. By fading down one channel and adjusting the calibrate control until a ¼-in. deflection is obtained on the c.r.t. the power output from the other channel can be measured. The amplifiers can be balanced by injecting equal 50c/s hum signals from each transformer secondary and adjusting the controls until zero deflection is obtained on the c.r.t. The same hum signal can be used to check loudspeaker phasing, out-of-phase loudspeakers producing much less output than in phase ones at any point in a normal-sized room. A special feedback circuit in this amplifier has enabled the crosstalk at 15kc/s to be reduced to 30 dB. Normally, the crosstalk is much greater than this at such high frequencies, due to capacitive coupling between the contacts of switches to which both channels must be connected.

Conversion to stereo is made easy with the Tripletone "Convertible" combined single-channel pre-amplifier and 4-watt amplifier by provision of spindles on both sides of the potentiometer controls so that, when two "Convertibles" are bolted together front to back, corresponding controls can be mechanically ganged together.

A stereo amplifier balance indicator unit was also introduced by Tripletone. In this the two amplifier outputs are fed in opposite phases to a single speaker so that zero output in this speaker indicates amplifier balance.

Elements of Electronic Circuits

6.—IMPEDANCE TRANSFORMING AND MATCHING

By J. M. PETERS, B.Sc. (Eng.), A.M.I.E.E., A.M.Brit.I.R.E.

A CIRCUIT widely used as an impedance transforming and matching device, possessing a low input capacitance, is the cathode follower. As shown in Fig. 1, it is essentially an amplifier with the anode load and bias capacitor omitted, thereby producing a large amount of negative current feedback. The output is taken across the cathode resistor R_k which

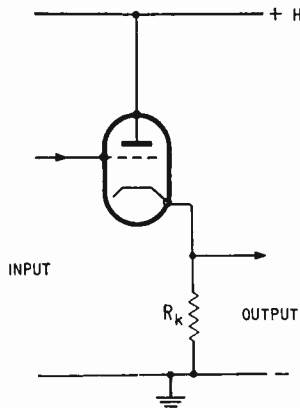

Fig. 1

is the load resistor. Voltage variations at the grid will produce anode (and hence cathode) current variations in phase, hence the cathode potential will rise and fall in sympathy with the grid voltage. It will be noted that the cathode voltage is in phase opposition to the anode voltage.

First let us consider the gain of such a circuit. In the absence of feedback let the amplifier have a gain A , then with feedback the new gain

$$A' = \frac{A}{1 + xA}$$

where x = the fraction of the output feedback. In this circuit let us assume $A = g_m R_k$ (it will be shown later that this is a legitimate assumption to make) and, as all the output is fed back, $x = 1$

$$A = \frac{g_m R_k}{1 + g_m R_k}$$

Now when $g_m R_k \gg 1$, $A' \approx 1$. Thus the gain approximates to unity.

It will be noted that the pentode approximation for gain, i.e. $g_m R_L$ (or $g_m R_k$ in this circuit as R_k is the load), has been used in the above reasoning although we are dealing with a triode cathode follower. This is permissible in pulse circuitry where small load resistors are normally encountered ($R_a \gg R_L$).

Now let us examine the output impedance. For an amplifier with feedback it can be shown that the output impedance is also reduced by the factor $1/(1 + xA)$ and can be written $R_o/(1 + xA)$ where R_o is the output impedance in the absence of feedback. For the cathode follower,

$$\text{output impedance} = \frac{R_k}{1 + 1 \cdot g_m R_k}$$

and when $g_m R_k \gg 1$ this tends to $1/g_m$. If we consider a high slope pentode with a g_m of, say, 10mA/volt, the output impedance is 100 Ω , i.e. very low compared with that of a conventional amplifier, and of a value suitable for matching to a cable or to an artificial line.

Finally let us examine the input impedance. In a normal valve amplifier, when the output voltage

is developed across an anode load resistor, the input admittance becomes a capacitive susceptance of value $\omega C_{gk} + \omega C_{ga}(1 + A)$ provided that the output voltage is in antiphase with the input, which is the case here. The input capacitance can therefore be written $C_{in} = C_{gk} + C_{ga}(1 + A)$, i.e. the input capacitance is increased by the factor $A \cdot C_{ga}$ due to the Miller effect. In the case of the cathode follower, since the anode is at earth potential so far as a.c. is concerned, C_{ga} may be considered as appearing across the input. Because the output voltage is now in phase with the input, the input admittance, still a capacitive susceptance, can be written

$$\omega C_{ga} + \omega C_{gk}(1 - A)$$

The input capacitance can therefore be written $C_{in} = C_{ga} + C_{gk}(1 - A)$. For a resistive load we have already shown that $A \approx 1$. Therefore the input capacitance reduces to C_{ga} , representing a much smaller input capacitance than that of a similar valve connected as a conventional amplifier.

Summarising, we have shown that the cathode follower possesses the following features:—

- (i) Low input capacitance and hence high input impedance at the frequencies considered.
- (ii) Low output impedance.
- (iii) A voltage gain of unity (or less).
- (iv) No phase inversion between input and output with a resistive load.

A circuit which in some ways is complementary to the cathode follower is the earthed-grid amplifier (Fig. 2), in that it possesses a low input impedance and a high output impedance. The anode and cathode voltages are in phase with each other.

The low input impedance can be used to advantage in the termination of cables but is more often used as the first stage of r.f. amplification in a receiver, where this attribute helps to prevent instability. A greater voltage amplification is possible than for a conventional amplifier using the same load.

It can be shown that if R_L is very small compared with R_a , and if μ is $\gg 1$, then the input impedance of the circuit approximates to $R_a/\mu = 1/g_m$ (similar to the output impedance of the cathode follower).

Examination of Fig. 2 will show that, because of the earthed grid, positive feedback due to the Miller effect can only occur through C_{ak} . As this is usually a very small capacitance, regeneration due to the feedback is minimized to a great extent.

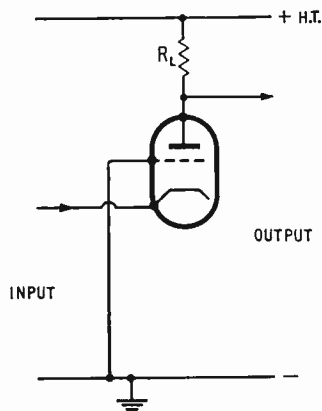

Fig. 2

INTERNATIONAL

FIRATO

in

AMSTERDAM



DURING the ten years of its existence the Dutch radio show has grown rapidly in size and importance. The 1950 show at Bellevue in Amsterdam covered only 3,400 sq ft; at this year's show, which was held from 1st to 8th September in the R.A.I. permanent exhibition building, there were over 200 stands covering an area of 220,000 sq ft and many applications for stand space had to be turned down. By next year the new R.A.I. exhibition buildings in the Europaplein will be ready for occupation, and it is expected that there will then be room for all. The accompanying photograph shows about half the area of the present R.A.I. building (there are annexes leading off to left and right).

The title of the exhibition is a play on the initials of the organizing body of the Dutch radio industry—the Fabrikanten, Importeurs, Agenten op Radio-gebied. The exhibition is by no means confined to domestic receivers and about a third of the space was occupied by measuring instruments, electronic equipment, transmitters and other capital goods. The manufacturing side of the Dutch radio industry, which includes the vast Philips organization, is by no means inconsiderable, but it is somewhat overshadowed—at least as far as this exhibition is concerned—by the large number of firms acting as agents and importers of foreign goods. Fully half of the stand space was occupied by dealers and some unusual sights were seen—for example, comprehensive and comparable displays of Hewlett-Packard, Rohde & Schwarz and Tektronix instruments side by side on the stand of C. N. Rood. Your reporter started to make lists of British firms (and of some of the German firms whose products had previously been noted at the Frankfurt exhibition), but he soon gave up—they were *all* represented somewhere in the exhibition in Amsterdam. So were many American, French and Japanese firms and there was one television receiver manufacturer “Rafena” from East Germany. It would have been impossible to do justice to all the interesting items seen at this exhibition in the short time available, and your reporter decided on this occasion to concentrate on the native products of Dutch industry which may not yet be so well known abroad.

A comprehensive range of first-class radio and television receivers, car radios and record players

is marketed under the name “Erres” by R. S. Stokvis & Zonen N.V. of Rotterdam, a large firm of domestic appliance manufacturers. The sets are made exclusively for Stokvis by the firm of van der Heem of The Hague, who are also well known as manufacturers of v.h.f. marine radio, stabilized power supplies and other electronic equipment, and the output of domestic receivers is generally acknowledged to be the second largest in Holland.

For viewers in the south of Holland, TV sets capable of receiving the four modulation systems used by stations within range in Holland, Belgium, France and Germany, are available from both Erres and Philips.

High-gain broad-band television aerials specially designed for receiving conditions in Holland are made by most of the Dutch aerial manufacturers. Two folded dipoles of unequal length, spaced and coupled together, form the active elements and in the Teweia Type TV510/09a aerial give gains, with a reflector and six directors, of between 9 and 10dB over channels 5 to 10. Another Dutch aerial firm, Messa Electronics N.V. of Rotterdam, makes a special feature of mechanical vibration damping by the use of loaded plastic clamps for assembling the elements. They also give a 3-year guarantee-certificate of electrical gain and mechanical performance with every aerial.

The range of Philips domestic radio, television and sound-reproducing equipment has already been noted in reports of the Earls Court and Frankfurt exhibitions, but several additional new developments were seen at Amsterdam. Most of the Philips table-model receivers and radio-gramophones on show were fitted with dual a.f. amplifiers and loud-speaker outlets operating on what is termed the “Bi-Ampli” principle. When reproducing stereophonic records, straight amplification is provided separately by each channel, but on radio reproduction the output from the detector is passed through filters, and low frequencies go the left- and high frequencies to the right-hand channel.

A new Philips television camera in cylindrical form measures only 8cm in diameter, and the Philips range of camera tubes includes a new vidicon, which at the time of our visit had not yet been given a type number. Also new is the Z510M



Main hall of the present R.A.I. exhibition buildings in Amsterdam.

decade numeral display tube. Transistorized units for digital computers with four bi-stable circuits on a printed-circuit board two or three inches square are new, and also cold-cathode programming units for industrial process control.

Philips have devoted considerable time and resources to the encouragement of an interest in radio and electronics among young people in Holland. First, there is a series of inexpensive constructors' kits, in which it is interesting to note that a start is made with transistors, for boys from 9 to 15 years, in simple "Pioneer" sets which can be wired without soldering and which lead to quite ambitious a.m./f.m. receivers with valves and, of course, soldering. There is even a build-it-yourself kit for a gramophone turntable. Second, a beautifully prepared series of coloured film strips and booklets showing the physical principles of valves and semiconductors; blackboard-sized working circuits and large sectional models of valves for use in schools and club lectures.

A visit to the Firato leaves little doubt as to the keenness of Dutch youth for construction and experiment and the stand of Amroh who make a wide range of constructors' kits was well beiseged, as were the stands of the publishers of technical journals and books. Amroh market a kit in which components are assembled on a perforated chassis to build first a simple crystal diode detector receiver to which may be added, step-by-step, up to three transistor amplifying stages, finally operating a loudspeaker. This is the simplest of a very complete series of kits for radio and high-quality record and tape reproduction. A special note was made of the quality of sound from the small (28 × 20 × 14in) "Verdi" reflex cabinet loudspeaker working on this stand: -

Gramophone motors, turntables, record changers and portable record players of Dutch design and manufacture were shown by the firm of Jobo N.V. who for some time have been making a very successful record changer ("Amusette"), in a distinctive circular housing of about 9in diameter. It plays up to twelve 7in, 45 r.p.m. records.

Servicemen were evidently interested in the Pope "universal TV-service koffer" (seen on the stand of valve dealers N. V. Malchus). This is a strong metal carrying case with foam plastic filling recessed

to take one each of all the valves required to service any given make of television receiver.

In the measurements section of the exhibition the Dutch firm of Peekel, whose multi-octave-band filters and strain-gauge instruments are widely known, were showing several new multi-channel strain gauges. Another Dutch firm, Nederlandsche Instrumenten en Electricische Apparaten Fabriek of Utrecht (N.I.E.A.F.), were showing a series of multi-range meters of original and functional styling in which both the meter and the range setting were very easy to read. Their "Polymeter-B" has d.c. ranges from 50 μ A to 10A and 100mV to 5,000V; a.c. 500 μ A and 2.5 to 5,000V; resistance 2k Ω to 20M Ω (all full-scale deflection).

A v.h.f. microvoltmeter (Type SM-2) designed by TEWEA (Technisch Wetenschappelijke Apparaten-fabriek, Amsterdam) is designed primarily for installation work on television aerials, which are the main product of the company. The meter has a frequency range of 46-230Mc/s and will read down to 10 μ V. It is battery operated (with built-in rechargeable Ni-Cd, low-tension accumulators) and weighs 12 $\frac{1}{2}$ lb.

Most exhibitions these days have their scientific "gimmicks" designed to catch the popular fancy, usually in the context of space travel, and the "star turn" at the Firato was a model of an earth satellite revolving slowly in orbit against a backcloth of the heavens. But the point of special interest was that the motor driving the model was powered by a panel of Ferranti silicon barrier-layer photo-cells illuminated by a small projector lamp of the kind used for viewing 35mm film strip.

Compared with the B.B.C. and I.T.A. exhibits at Earls Court the technical demonstrations of the Dutch N.R.U. and N.T.S. were small in size but every bit their equal in quality. Listeners' and viewers' problems were dealt with competently and sympathetically and there were demonstrations of television monitoring techniques and of the use of synthetic reverberation in sound broadcasting.

The untimely death last June of H. J. Kazemier, who was largely responsible for the establishment and growth of the Firato, was deeply felt by all sections of the industry, but it was generally agreed that this 10th exhibition was the complete success that he would have wished.

Distributed-Amplifier Transmitter is an unusual design just introduced by Marconi's which permits transmission on any frequency in the h.f. band without the usual re-tuning of r.f. power amplifiers. Transmission on two or more frequencies simultaneously is also possible. Distributed amplifiers are commonly used for wide-band amplification at low levels (e.g. in oscilloscopes) but not at high powers. The Marconi equipment has an output of 1kW in the range 2-24Mc/s. Basically the distributed amplifier consists of two artificial transmission lines with a series of valves between, the grids being connected to successive points on one line and the anodes to corresponding points on the other. The valves' grid and anode capacitances provide the shunt capacitances of the two lines, which are terminated by appropriate loads at both ends. An input signal applied to one end of the "grid" line travels along and each valve grid is driven in succession. In the "anode" line, the amplified signals produced in succession at the anodes also travel along, with corresponding time delays, and add up in the output load at the end of the line. (Actually half of the anode current of each valve travels to the output load and the other half travels in the opposite direction to be dissipated in the other terminating load.) There are two stages of such distributive amplification in the transmitter, giving gains of 26dB and 25dB respectively. Both stages have two distributed amplifiers, operating in push-pull to reduce even harmonics and improve overall efficiency. The system is insensitive to the nature of the load impedance to the extent that a 2:1 s.w.r. on the output feeder is permissible without appreciable reduction in output power.

Programmed Power Supplies, giving a sequence of pre-selected voltages, are the latest idea for rapid and automatic testing of equipment on production lines. The voltages are available as steps in a range (say 1-volt steps in a 100-volt range) and are switched as required to the equipment under test by means of instructions from punched cards, magnetic tape or other media. In a range of programmed power supplies manufactured by Southwestern Industrial Electronics, of Houston, Texas, U.S.A., the control is performed by binary-coded decimal data, and there is an error-correction system for making sure that the desired voltages have been properly selected. Stabilization is provided by transistor and magnetic-amplifier regulator circuits.

Tape Recording Mystery which has puzzled many people for years is the exact nature of the magnetization process by which the signals are recorded, using the h.f. bias method. L. H. Bedford, writing in the Sep-

Technical Notebook

tember, 1959, issue of *Electronic & Radio Engineer* analyses the phenomenon in detail and advances an interesting new theory to explain the mechanism. One conclusion is that what is "written" on the tape is a distorted version of the bias waveform, consisting of alternately polarized quarter-cycles of constant magnetization separated by quarter-cycles of transition. In the case of saturation bias, the signal is "written" as a variation of the mark/space ratio of this distorted waveform. With normal bias this mechanism also applies, but to it is added a variation in the relative magnitudes of opposite quarter-cycles of constant magnetization. Recording takes place at the trailing edge of the recording gap, so the length of this gap is not of primary importance.

Beam Microphone with a directional response characteristic nearly independent of frequency is described by H. J. Griese and O. Hoffmann in the February 1959 issue of *Radio Mentor*. This microphone is a development of the "nest of tubes" type in which the acoustic input feeds into a single tube of varying cross-section. Unfortunately, microphones of this type have responses which become more directional if the frequency rises. This change in the response can be avoided by arranging for the effective length of the tube to decrease with increasing frequency. In the new microphone this is done by inserting low-pass filters in the side of the tube. Each filter consists of a small hole acting as an acoustic mass which feeds via an acoustic resistance, capacitive enclosure and final hole acoustic mass into the open air.

Mercury-Wetted-Contact Relay, not to be confused with the conventional mercury relay, has precious metal contacts, enclosed in a glass tube, which are continually wetted by mercury supplied to the contacts by capillary action. It can be used in circuits for switching very heavy currents or in low-level applications where contact resistance is important. Originally developed by Bell Telephone Laboratories, the relay is used extensively in the U.S.A. It is now available in this country from Elliott Brothers (London). A life expectation of 10^9 operations is claimed, at speeds of operation up to 3 milliseconds, and the consistency

of operation is said to be within 1% of the minimum operating current.

Getting a Word in Edgeways, to a degree undreamed of by the most determined cocktail-party conversationalist, is achieved in a multi-channel telephone system now being developed at Bell Telephone Laboratories. Known as TASI (for Time Assignment Speech Interpolation) the system aims at increasing the capacity of submarine telephone cables. It is a kind of random time division multiplex system which makes use of the unused time occurring in the natural gaps and pauses in conversation and in the silences when one person is listening to the other. By means of electronic sampling and distribution the speech of any one person is switched from channel to channel according to the speech gaps which occur in those channels. When this person himself is silent, his channel is disconnected momentarily and used for the other conversations. In this way it becomes possible to connect many more talkers through a submarine cable than would normally be possible with the available number of channels.

Vibrating Pressure Transducer, giving an electrical signal output of which the frequency is proportional to mechanical pressure, has been put on the market by Solartron. It is actually a development of the Swedish firm Svenska Flygmotor Aktiebolaget. The vibrating element of the transducer is a cylinder, and the natural vibration frequency of this is varied by applied pressure in much the same way as the natural frequency of an electric bell trembler is varied by adjusting the stop which



bears against it. Excitation is from a miniature transistor feedback amplifier built on a printed circuit and encapsulated. In association with the mechanical system this forms an oscillator, the frequency of which indicates the applied pressure. The

frequency-variation system has the advantage that its accuracy is not affected by noise or other perturbations as an amplitude-variation system would be. Consequently the detecting and measuring apparatus can be situated at a considerable distance from the transducer itself. The transducer can also be used for analogue-to-digital conversion by counting the cycles of the output signal waveform.

Cold-cathode Tubes are usually thought of as being gas-filled devices in which the current is transported across the tube by the ionised gas. However, an electron-emitting cold-cathode has been developed in the U.S.A. by the Signals Corps Research and Development Laboratory and a subsequent contract to Tung-sol Electric Inc. has realized a practical hard-vacuum a.f. output valve using a cold cathode. The first discovery made was that a thin layer of magnesium oxide deposited on nickel continued to emit electrons after bombardment with an electron beam had ceased. By altering the positive potential applied to a collector electrode the emission could be varied from a few microamps to tens of milliamps, and could be maintained for many hours. It is thought that an avalanche process is started across the thickness of the cathode coating by a steep potential gradient built up when the first few electrons are emitted. This results in electrons reaching the surface of the coating with sufficient speed to shoot themselves free; then they come under the accelerating influence of the positively charged surrounding electrodes. The output valve developed resembles in structure a pentode. G_1 and g_2 are connected to a positive potential (about 300V minimum) through a limiting resistor—these form the emission sustaining grids—and g_3 is used as the control grid, which is again given a positive bias; but this is of smaller magnitude than that applied to the maintaining grids. Emission is started by “flashing” momentarily a lamp-like filament near the cathode. About 0.75W (roughly a tenth of the equivalent hot-cathode power) is required by the maintaining grids. Initial cost and noise level are similar to that of a hot-cathode valve and a sample has been in operation for about 14,000 hours without any decrease in emission. Further details are to be found in *Electronics* for February 6, 1959.

Data Recording Errors on magnetic tape can be avoided by a new technique devised by E.M.I. Electronics, for systems which require the use of at least two tracks on the tape simultaneously. For example, the required path of a machine tool cutter may be recorded as the phase modulation of a carrier signal relative to an unmodulated carrier on

another track. Or readings from several instruments and from a clock may be recorded on parallel tracks for later study of their time relationships. In each case the information may, to some extent, be distorted if, either on recording or replay, the line of heads is not at the standard angle of 90° to the travel of the tape. This error can be overcome if one of the recorded signals, preferably one which is a simple sine wave, is recorded on duplicate tracks near the outer edges of the tape. In the simple case where there are only two signals, one will be recorded at both edges and one at the centre of the tape. If the head is tilted, one of the outer channels will be advanced, and the other retarded, relative to the timing of the centre track. But if the two outer head signals are added together they will provide a reference signal in which the errors are very nearly compensated. The limitation is now eased to the extent that the edge tracks can be mis-timed to, say, $\pm 40^\circ$ of the clock signal phase before the reference becomes inadequate. If there are several information channels, as well as the duplicated reference channels at the edges of the tape, the signals from the two reference heads can be mixed in different proportions to generate the reference for the various data tracks. For instance, a track 30% across the width of the tape should be interpreted with regard to a reference generated by adding 70% of the first head signal to 30% of the last.

Light-Weight Submarine Cable, armourless and non-twisting, has been designed by the British Post Office and developed by Submarine Cables. Instead of the conventional outer armouring it has a central stranded steel wire to provide its mechanical strength. This is enclosed in a copper tube, to provide the central conductor of the coaxial system, and insulated with polythene

to a diameter of approximately one inch. Aluminium tapes (the outer conductor), together with a polythene binder tape and one aluminium screening tape with a polythene interleaving tape, are applied next. The whole is then given a lapping of anti-corrosion tape and an outer covering of polythene to an overall diameter of about $1\frac{1}{4}$ inches. The light-weight cable can be handled much more easily than armoured cable and this facilitates the laying of the repeaters. An order for 1,635 nautical miles of it has been placed by Cable & Wireless for the first section of the Commonwealth round-the-world telephone system. This will be laid between Scotland and Newfoundland in the summer of 1961.

“Sieve” Particle Counter, designed by F. J. G. van den Bosch, of Anvers, Belgium, is notable for its simplicity compared with many previous instruments. It is basically a television microscope (using an industrial type camera and monitor) combined with an electronic counter. The “sieve” is formed by a series of black horizontal lines on the scanning raster, produced by a pulse generator as a kind of coarse auxiliary raster. Only the particles on the microscope slide which appear between these lines are counted. Since the magnification of the optical/television system is known, the spaces between the lines represent known distances on the microscope slide. Particles of a certain size can therefore be selected for counting simply by adjusting the microscope so that the images of the particles on the monitor screen just fall between the black lines. The video signal from the camera is applied to the counter through a gating valve, which is normally “closed” but is “opened” by pulses from the generator producing the coarse auxiliary scan. Thus, only the video signal pulses representing the particles between the black lines can pass through to actuate the counter.

Moon Surface Study by radar is being undertaken jointly by the Radio Astronomy Group of the Royal Radar Establishment, Malvern, and the Electrical Engineering Research Laboratory of the University of Texas. Recently, radar pulses of 10-cm wavelength and 5 μ sec duration were transmitted to the moon from the 45-ft radio telescope at Malvern, using a power of 2 megawatts and a repetition frequency of 250 p.p.s. The reflected signals were received both at Malvern and in Texas. Comparisons between the two sets of signals received are expected to give information about the moon's surface and its suitability as a reflector for long-distance transmission of sound and television signals.

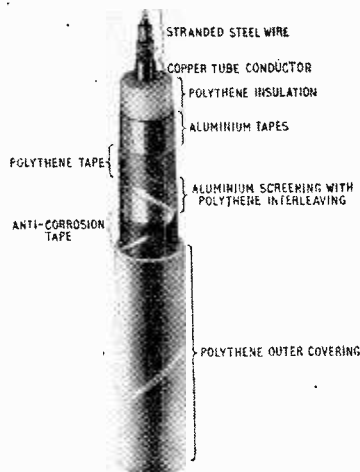

Hum, Rumble and Noise

By R. E. COOKE* B.Sc. (Eng.)

IN the development of high-quality sound reproduction, almost as much effort has been expended on the suppression of background noise as on the reduction of distortion and the extension of frequency range. There is no greater bar to realism than the irritating hiss of surface noise or a diverting low-frequency background of hum and rumble. Furthermore, these troubles are exposed more readily by wide-range equipment: as P. P. Eckersley put it many years ago: "The wider you open the window, the more the dirt blows in".

The Disease.—Disc stereo adds to the problem for the following reasons:—

(a) Two-channel working involves more wiring and connections, with increased liability to hum pick-up and earth loops.

(b) Stereo pickups of the moving coil and variable reluctance types generally give less output than their mono equivalents and thus require higher amplification which increases the liability to hum and noise. Crystal and ceramic pickups are less prone to hum trouble because of their higher output and non-inductive construction.

(c) Stereo pickups respond to vertical as well as to lateral vibrations. Turntables which are quite satisfactory for some working may be unacceptable for stereo, especially if the frequency of vertical rumble coincides with a low-frequency vertical resonance in the pickup.

(d) Although not strictly a noise problem, the increased freedom of stereo pickups plus greater amplification intensifies the risk of mechanical feedback. When this occurs, over-emphasis of the bass will result, with strong coloration at the frequency of feedback.

Diagnosis and Cure.—The following suggestions will help to avoid major pitfalls; but in difficult cases it may be necessary to call in an expert, as it is impossible to cover all the combinations of factors which can cause high background noise. Nor is it possible to diagnose the trouble by letter. The only satisfactory procedure is to investigate the installation *in situ*. Removing all or part of the equipment to a workshop for servicing may preclude a proper diagnosis.

Hum may be induced in the pickup head itself or in the wiring to the amplifier input. Efforts to reduce hum, therefore, take two general courses. One is to reduce as much as possible the stray alternating magnetic fields which surround the pickup and associated leads. The other is to arrange the wiring to minimize hum induction by inevitable residual stray fields.

The turntable motor itself is often a major source

of trouble because it is situated very close to the pickup and input leads. For quiet background, the motor should have a very low stray field; but few manufacturers quote measurements which would enable an intending purchaser to assess the position. Designing for low stray field is a question for the manufacturer, as little can be done afterwards to improve matters. Points of good design are the use of high-grade motor field laminations giving low working flux density in the core, and thick iron motor casings to act as magnetic screens.

Very small motors may be shielded by wrapping with Mumetal tape; but the high cost of this material precludes its general use with larger types. In a typical case, using a high-quality variable-reluctance pickup which is particularly prone to hum pick-up, the hum level fell by 12 dB when used with one high-grade transcription turntable, compared with another turntable of similar mechanical quality. This striking improvement was due simply to the much lower stray

field. With some motors in which working flux density is very high there is a tendency to produce excessive stray field when the supply voltage is near the upper limit, due to magnetic saturation. A useful reduction in hum is often possible if the voltage is reduced at the motor terminals by means of a series dropping resistor. In a typical case with the motor operating from 240 V, 50 c/s, hum was reduced by 2 dB after inserting a series resistor of 500 ohms, 5 watts rating, which cut the voltage down to 200 V. Other motors may show an even bigger hum reduction after dropping the terminal voltage. The variation of stray field intensity with mains supply voltage may also explain the increase in hum at certain times of the day when the mains voltage rises. This generally occurs in the evenings and at weekends (due to the drop in industrial consumption of electricity, including one Saturday afternoon in particular, during a demonstration in the Royal Festival Hall).

The mains transformer of the power amplifier is also a prolific source of hum, with a surprisingly large field of radiation. When assembling equipment in a cabinet, the power amplifiers and any other mains transformers should be located as far away as possible from the pickup and input wiring. It should also be remembered that magnetic fields are "directional" and some reduction in hum is often possible by arranging the amplifiers at certain angles. The best position can be found only by trial and error. When testing for hum, the pickup should be swung back and forth through its playing arc, *close to the turntable*, because the hum level can vary with posi-

* Wharfedale Wireless Works, Ltd.

MINIMIZING THE RESIDUAL
BACKGROUND IN HIGH-
QUALITY SOUND EQUIPMENT

tion by as much as 6 dB. In a stereo installation, each channel should be tested separately to avoid being misled by possible acoustical phase cancellation at the listening position. The hum will rarely be found equal in both channels.

To minimize hum induction the leads between pickup and amplifier should be as short as possible and kept clear of motors and mains transformers. Screened cable is essential for all except moving-coil pickups of very low impedance, and the leads for the two channels should be strapped together to avoid hum loops. If it is necessary to extend the leads provided by the pickup manufacturer, the joints should be soldered and insulated with good quality plastic tape. (Bituminous insulating tape is not reliable for this work.) The insulated joint should then be wrapped with tinned copper wire to act as a screen, and this should be soldered to the earthy braid on both sides of the joint. If intermediate plugs and sockets are required, as for example in demonstration equipment, these should be good quality shielded types, and must be placed as close together as possible.

The relative amounts of hum induced in the pickup itself and the input leads can be assessed by removing the pickup head and shorting together all the connections in the arm, using a *very short* length of thick wire. The residual hum is that due to the wiring alone.

Hum Bucking.—Where it is impossible to rearrange the equipment to eradicate hum, some improvement may be effected by using a hum bucking coil. A simple method is to bend a section of the pickup input lead in the form of a loop about 2in in diameter. This should be brought close to the mains transformer of the amplifier and its position adjusted to give minimum hum while playing a record.

This arrangement deliberately injects a small voltage at mains frequency into the amplifier input in series with the signal. The magnitude and phase of this voltage are then adjusted by altering the position of the loop in the stray field from the transformer until maximum cancellation occurs.

It has already been pointed out that the hum in both channels is rarely equal, either in magnitude or phase. Furthermore, the hum signal varies with pickup position so that a hum bucking coil cannot produce a complete cure. It is always necessary ultimately to remove the cause of hum at its source.

Earthing.—Whereas with mono equipment it is frequently possible to dispense with an earth connection and still retain a satisfactory hum level, it is usually essential to earth stereo equipment. Earthing should be carried out at one point only, usually at the amplifier. All the other equipment, such as turntable and tuner unit, should be earthed via the screened leads which run to the amplifier input sockets.

As an example of the improvement which may be expected by careful attention to these various details, the peak signal to hum level of a typical installation using a hum-sensitive, variable-reluctance pickup, was initially 32 dB. Rearranging the wiring increased this to 35 dB, and changing the turntable motor for one with a lower stray field produced a final figure of 47 dB. Disconnecting the mains lead from the motor brought the signal to hum ratio up to 54 dB, indicating that further improvement was still possible; but for practical

purposes a figure in excess of 45 dB is adequate. **Rumble.**—It has already been explained that the vertical sensitivity of a stereo pickup increases its tendency to expose turntable rumble, and that the coincidence of pickup resonances with certain rumble frequencies can also intensify the effect. It is therefore difficult to estimate precisely how much rumble will be obtained from any combination of turntable and pickup, especially as wide variations can occur between examples of the same models.

The method of mounting the turntable can affect the rumble content. It is usual to "float" the turntable mounting board on four corner springs in order to reduce mechanical feedback, and to isolate the pickup from external vibration. Unfortunately this sometimes allows resonances to build up in the mounting board, and rumble may often be reduced as much as 8 dB by clamping down the motor board firmly. The improvement is due to the added mass of the cabinet which is coupled up to the motor board by clamping the suspension springs.

It is unfortunate that a spring-loaded turntable which is useful in avoiding mechanical (acoustic) feedback may be bad for rumble. (What you gain on the springs you lose on the roundabout.)

Pickups having a pronounced low-frequency vertical resonance may be shock-excited when the stylus is lowered abruptly on to the record. The use of a pickup lowering device is useful in minimizing the shock as well as in safeguarding the delicate pickup mechanism. Such a device is in fact essential in professional work where the record has to be "faded up" at a precise point.

Mechanical Feedback.—This fault is caused by mechanical transmission between loudspeaker and pickup. The cure is to reduce this coupling as much as possible. The turntable should be placed well away from the loudspeaker and mounted on springs. It is also beneficial to stand the loudspeaker on a thick pad of foam rubber or rubberized hair so as to isolate it from the floor. It is usually possible to find a strategic position for the turntable, giving minimum feedback. This may often be near a fireplace where the floor boards are firmly braced, or on a section of floor which is not coupled directly to the loudspeaker through common joists. Moving the loudspeaker might also make a big difference.

Vibration.—All modern, high-grade pickups which operate with very low playing weight are liable to reproduce random vibratory disturbances such as those caused by walking across insecure floorboards. This trouble is even worse with stereo pickups because of their two-dimensional sensitivity.

As with mechanical feedback trouble, some improvement is obtained by spring mounting the motor board; but if the centre of gravity of the turntable/pickup assembly is not located immediately below its geometric centre, the motor board will oscillate about the centre of gravity with a rotary motion.

This condition can produce spurious noises, and in bad cases cause loss of tracking or even groove jumping. A method of improvement suggested by R. L. West and described in the September issue of *Wireless World* consists of adding weights to the motor board in strategic positions to bring the centre of gravity under the geometric centre. This can be done experimentally by freely suspending the motor board from each pair of diagonally opposite corners

(Continued on page 455)

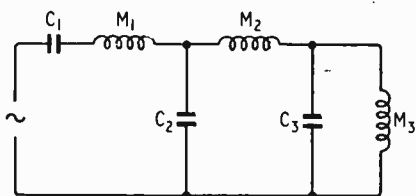
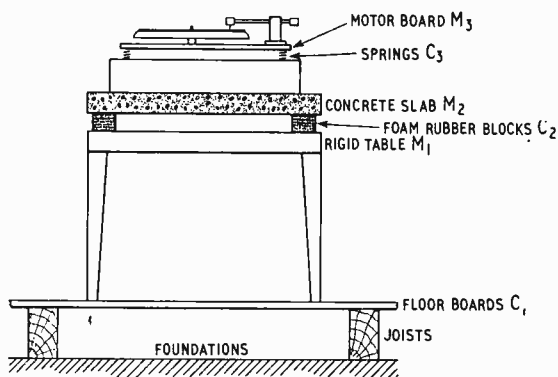

Method of isolating turntable from floor vibration, with (below) the equivalent electrical analogue circuit.

in turn and adding weights, until the board balances horizontally. After returning the motor board to its spring mountings, any transmitted vibration will then cause only vertical oscillations and consequently less disturbance of the pickup. As a bonus, the added weight will lower the resonance frequency of the turntable on its springs, giving improved isolation.

When giving demonstrations in large halls, more

stringent precautions may be required. Two thousand souls shuffling about on a wooden floor can play havoc with a delicately poised pickup. An effective remedy is to use a two-stage vibration filter as shown in the accompanying diagram.

Such an arrangement is rather complicated for general use, but the lesson it teaches may be applied to domestic installations if the need arises.

Noise.—It is surprising how often people accuse loudspeakers of producing hiss when they should really be investigating their amplifiers. There is always a certain amount of valve noise from any amplifier, but with modern high-quality types this should only be apparent as a faint hiss with the ear about one foot from the h.f. loudspeaker and the controls at normal settings. If the hiss becomes obtrusive it is usually a sign of trouble: perhaps a faulty valve or incorrect installation.

When testing for valve noise, the pickup should be left off the record, as many pressings have a high level of background hiss. The same applies to pre-recorded tapes.

Conclusion.—It seems obvious that the advent of stereo on disc is going to demand improved standards of performance from turntables, as did the transition from standard 78s to l.p.s a few years ago. It must be admitted that rumble is not produced exclusively by turntables. Records themselves sometimes contain rumble as well as other low-frequency background noises; but the best discs are still superior to the average transcription turntable in this respect. Some U.S. manufacturers are already reverting to belt-driven turntables which offer some reduction in rumble at the expense of increased complexity where speed variation or adjustment is required. Only time will produce the most satisfactory and economical solution.

BOOKS RECEIVED

Oszillatoren mit Schwingkristallen, by Werner Herzog. General treatise on piezoelectric oscillators and their associated valve and crystal circuits—including some reference to crystal and atomic clocks. Pp. 317; Figs. 284. Price DM45. Springer-Verlag, Heidelberger Platz 3, Berlin-Wilmersdorf.

Servicing Transistor Radios, by Leonard D'Airo. Transistor fundamentals, servicing techniques, and descriptions of various types of transistor circuits. Includes data on the principal American transistor types. Pp. 224; Figs. 215. Price \$2.90. Gernsback Library Inc., 154 West 14th Street, New York, 11.

Elementare Einführung in die Bessel-Neumann-und Hankel-Funktionen, by Walther Rehwald. Elementary treatise on Bessel, Neumann and Hankel functions with numerous examples of their application in physics and technology. Pp. 46; Figs. 19. Price DM 6.30. S. Hirzel Verlag, Birkenwaldstrasse 185, Stuttgart N, West Germany.

R.S.G.B. Amateur Radio Call Book. 1959 edition of call signs of licensed amateurs in the United Kingdom and Eire. Includes lists of prefixes of all countries of the world. Pp. 64. Price 3s 6d. Radio Society of Great Britain, New Ruskin House, Little Russell Street, London, W.C.1.

A Guide to Amateur Radio. Seventh edition of the R.S.G.B. handbook for newcomers to the hobby of

amateur radio. Choice of equipment, hints on operating, licensing examinations, etc. Pp. 72; Figs. 38. Price 3s 6d. Radio Society of Great Britain, New Ruskin House, Little Russell Street, London, W.C.1.

The Radio Amateur Operator's Handbook. Fifth revised edition of data book compiled in collaboration with the International Short Wave League. Pp. 48, illustrated. Price 3s 6d. Data Publications, Ltd., 57 Maida Vale, London, W.9.

Spotlight on B.B.C. Television. Guide for viewers on how television works and how to get the best results from a television receiver. Pp. 23, illustrated. Price 9d. B.B.C. Publications (Spotlight), 35 Marylebone High Street, London, W.1.

Audio Measurements, by Norman H. Crowhurst. Describes test instruments and basic methods of measuring the performance of amplifiers, pickups and arms, turntables, tape recorders and microphones. Pp. 223, Figs. 1029. Price \$2.90. Gernsback Publications Inc., 154 West 14th Street, New York, 11.

Television Engineers' Pocket Book. Edited by J. P. Hawker. Second edition now includes information relevant to Band III as well as Band I receivers and methods of testing. Pp. 252; Figs. 144. Price 12s 6d. George Newnes, Ltd., Southampton Street, London, W.C.2.

Paris Radio Show

IMPRESSIONS AND COMPARISONS

ALTHOUGH the French radio show was somewhat smaller than our own, it was every bit as crowded and hot. In general too, similar kinds of exhibitors were present—non-manufacturers included Radio-diffusion Television Francaise and many journals.

As regards quality, there seems to be rather more treble and less bass in Haut Fidélité than our own home-grown variety. Television pictures although better, did not seem to us to be 819/405 times as good as our own. Television—Development seems in general to be held up pending the arrival of 110° sets. These should not be long in coming however, since 110° c.r.t.s and components have already been shown at other exhibitions.

The uncertainty about a possible second TV programme seems to have been somewhat clarified by the planning of experimental transmissions in Channel 12 and the u.h.f. Bands IV and V. A few sets which will be able to receive these transmissions were already on show—u.h.f. front ends are fitted to some Grandin receivers and Channel 12 is receivable on some Pathe Marconi (La Voix de son Maitre) models.

Mains transportable sets seem to be very scarce in France—we noticed only a very small (9-in) one shown by Tele Portable (Paris-Auto-Radio).

In certain parts of France reception of television programmes from other countries is possible. However, since these programmes have different characteristics, multi-standard sets have to be provided to receive them. Among the numbers of such receivers on show we saw one, the Telemaster Super V5D FM, which could receive as many as five types of television transmissions—819 lines on French and Belgian standards, 625 lines on Belgian and European standards and even our own familiar 405 lines—not to mention f.m. sound broadcasts in Band II. Two simultaneous different language sound transmissions are used in French TV broadcasts to North Africa, so that in the Clarville Videomatic Special VS43 we find a socket for a “décodateur bilingue”—a piece of equipment we would have found very useful ourselves. (For further details of the transmissions and a simple decoding system see the *Technical Notebook* section of our February and March 1957 issues.)

Strong emphasis is placed on automatic controls in French sets. Although on investigation these usually only turned out to be the familiar vision and sound a.g.c., for example, we did note in Grandin and Point Bleu (Blaupunkt in Germany) receivers the use of a photoelectric cell to automatically adjust the contrast to suit the amount of ambient light.

This emphasis on automation also appears in the common availability in France of remote control units for the contrast, brightness, volume and on/off switch.

Provision for adding facilities such as flywheel sync, vision or sound impulsive noise limiters and pre-amplifiers is another common feature of French sets seldom found in England.

Also frequently found in French receivers is a control for modifying the vision bandwidth and/or frequency response to suit different types of transmission (studio, film or outside broadcasts for example) or different reception conditions.

Quotation of the vision bandwidth is also very common in France. 9Mc/s was the usual figure given but 10Mc/s was also quite often quoted. Another often-quoted useful figure was the receiver sensitivity, together with the conditions under which it was measured.

A pair of speakers placed one in each side of the cabinet so as to broaden the apparent sound source is another common feature of French television receivers.

A compact type of combined model not seen in

England but shown in France on the Grammont, Minerva-Radio and Phenix stands is a table television receiver with a record player above it and a radio below.

An unusual feature of some Grammont receivers is a neon tube placed round the screen edge so as to give a “douce et reposante” (soft and restful) surround without any reflection from the screen itself. A reflecting surround and the light from the screen itself was used to produce a similar effect in Pathe Marconi receivers for example.

Problems in television receivers due to mains voltage fluctuations seem to be much more serious in France than in England, since three exhibitors specialized in mains stabilizing units. These problems mainly arise because the fluctuations themselves, being sometimes as much as 50V in 120 or 220V, are much greater in France; but we also formed the impression that French receivers are somewhat more sensitive to this type of disturbance. Stabilization in such units was usually obtained by means of a saturating iron core system, the harmonics in the supply frequency produced by this stabilizing system being reduced by means of a filter. Inbuilt stabilization against mains voltage changes was specifically claimed for Schneider receivers for example.

Stereo.—Although this was apparently the first public showing of stereo in France, this was not, perhaps fortunately for the French, being pushed nearly so hard as it was last year in England. For example, manufacturers seldom felt it essential to provide hastily constructed adaptors for all their mono equipment.

Although examples were seen of nearly all the loud-speaker mounting arrangements used in English stereo—a long single cabinet was shown by Ribet-Desjardins, two separate cabinets by Clarville and separate column-shaped speakers by Supertone—it was the solution of a record reproducer with two detachable lid/baffles or a single split lid/baffle which was almost universally adopted by French manufacturers.

In connection with the usual limitation of the overall apparent sound field in single-cabinet stereo to the cabinet width it was depressing to note a stereo reproducer only 21in wide—9in less even than the narrowest we had previously seen in England.

Besides their stereo transmissions using two separate transmitters for the left and right channels, Radio-diffusion Television Francaise are also experimenting with a single transmitter f.m. Band II system in which the right-hand channel is carried on an a.m. sub-carrier spaced 70kc/s from the main carrier. Using close-spaced microphones, it was thought that stereophonic effects were mainly due to time rather than amplitude differences between the two channels, so that either channel by itself would provide a compatible programme.

Record Reproduction.—Removable lids containing the loudspeakers were also very popular in single-channel portable record reproducers. To reduce the depth taken up by the speaker, an inverted construction with the magnet inside the cone angle was quite often adopted.

A worth-while facility of relatively inexpensive record reproducers shown by Supertone, Radialva and Radiola was a pickup raising and lowering device for reducing the possibilities of damaging the record. Although such devices are not, of course, new to England, here they are generally seen only on the most expensive equipment.

An unusual feature of the Pathe Marconi 359 record reproducer is that both the bass and treble can be modified using a single control. According to which way the control is rotated, either bass or treble cut is produced,

High Fidelity.—The attention devoted to high-quality reproduction was much less in the French than the British Radio Show, for there was no French equivalent of our Audio Hall, few separate loudspeaker enclosures were shown and, except in the case of tape recorders, hardly any exhibitors showed only high-quality equipment without any “bread and butter” exhibits.

Two unusual features of the Supertone S9 loudspeaker are a cylindrical diffuser in the cone apex, and a rear-loading labyrinth enclosure whose cross-section decreases away from the loudspeaker.

The Raxon (shown by A.B.P.) consists of a record-cleaning bristle pad carried on a light arm so that it “plays” the record to clean it—a similar arrangement to an old familiar—“le Dust Bug”—shown by Hi-Fa.

Tape Recording.—We could see little evidence in France of the recent English trend towards providing a response up to the highest audio frequencies at a tape speed as slow as $3\frac{1}{2}$ in/sec rather than, as formerly, only at $7\frac{1}{2}$ in/sec. This is perhaps surprising as this improvement was first made possible in England by means of heads of Continental origin.

The erase/bias frequency does not seem to be nearly so standardized in France as it is in England—we noted the high value of 100kc/s in the Teca Plain Chant and the low value of 40kc/s in Seravox recorders.

Other unusual tape recorder features noted were separate bass and treble amplifying chains in the Philips EL3524 and Radiola 9524 recorders, provision of as many as 4 speeds in the Melovox recorder, and stereo record as well as replay facilities in a Teca recorder.

A feature of “double-play” tape shown by Kodavox is that the magnetic particles are oriented in the same direction so as to provide an increased output at reduced distortion.

Sound Receivers.—There are several types of control which are more common in these in France than England. These include tone-compensated volume (“loudness”), variable selectivity and bandwidth short wave controls. Both continuous and switched long wave-band tuning is also often provided; the switched stations being France I and Radio Luxembourg’s French service. Also very popular in France are tone controls which are switched to correspond to the type of programme being reproduced. For example the Clarville Auditor gives treble boost for “orchestre”, bass and treble cut for “solo”, bass and treble boost for “jazz”, and middle-frequency boost for “parole”.

Oriental aerial coils are often provided as in England,

but these are often air- rather than ferrite-cored. On the other hand, ferrite loudspeaker magnets are more common than in England.

A most unusual type of equipment shown by Radio-Celard consists of a combined decorative frame aerial and r.f. pre-amplifying stage designed to feed into an ordinary receiver. Examples were shown which were decorated to resemble pictures, globes and clocks.

Styling in French radio receivers often seems to include—we think successfully—asymmetrical elements. For example, the tuning scale may consist of a quadrilateral with two parallel and two non-parallel sides.

Useful facilities in valve car radios shown by Arel and Philips were automatic station searching and tuning with choice of minimum sensitivities below which no stations were selected.

Transistorized Models.—Record players and receivers were very common, more so than in England. In spite of this, transistorized radio-grams were rare—we noted only models shown by Grammont, Phenix and Radio-Celard.

Although we saw relatively few miniature transistor sets, and push-pull output stages were general, the latest English extension of this trend towards improved audio quality—loudspeakers and cabinets corresponding in size to ordinary valve table receivers—did not seem to be in evidence in France.

On the other hand, while in England extension to the shorter wavebands is only just beginning in transistor sets, in France such wavebands are very commonly provided even down to 16 metres, though often only to 46 metres. Even v.h.f./f.m. Band II transmissions can be received by the L.M.T. model T400. Telescopic aerials are generally provided for such short waves.

The English trend of making transistor receivers suitable for use in cars by providing a car aerial socket has also been extended further in France. In one arrangement shown by Ducretet-Thomson, Grammont and Pizon for example, the basic receiver unit can be removed from its normal cabinet for more convenient fitting in a compartment on the car dashboard. Arrangements were also often made to increase the receiver output in the car to allow for the increased ambient noise. In the Pizon receiver this increased output results simply from the greater current capacity of the car battery, while in other models shown by Firvox, Oceanic and Radio-Celard for example an extra several-watt transistor power output stage and larger speaker are provided in the car.

SHORT-WAVE CONDITIONS

Prediction for October

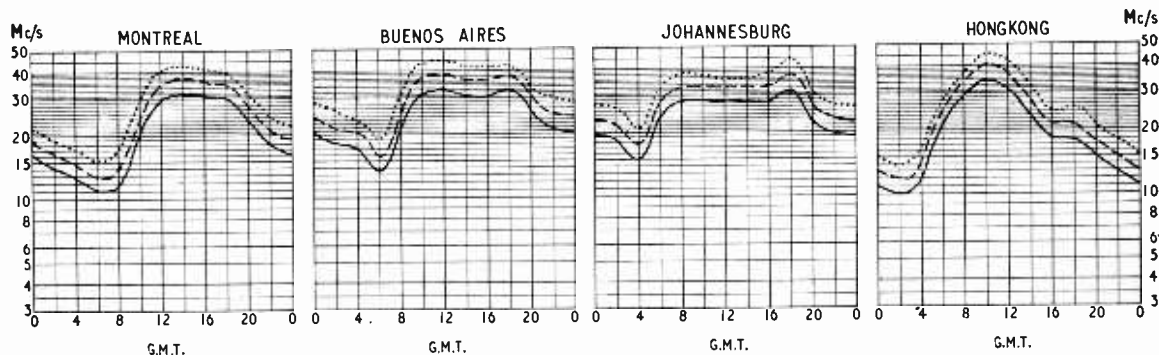

THE full-line curves indicate the highest frequencies likely to be usable at any time of the day or night for reliable communications over four long-distance paths from this country during October.

Broken-line curves give the highest frequencies that will sustain a partial service throughout the same period.

- FREQUENCY BELOW WHICH COMMUNICATION SHOULD BE POSSIBLE FOR 25% OF THE TOTAL TIME
- PREDICTED MEDIAN STANDARD MAXIMUM USABLE FREQUENCY
- FREQUENCY BELOW WHICH COMMUNICATION SHOULD BE POSSIBLE ON ALL UNDISTURBED DAYS

FERROELECTRICS

3.—THE DIELECTRIC AMPLIFIER AND SOME COMPUTER APPLICATIONS

By J. C. BURFOOT*, Ph.D.

(Concluded from July/August issue)

THE previous articles showed that a prominent mark of a ferroelectric is its strong non-linearity; the polarization P , instead of varying in proportion to the applied voltage V , rises very rapidly at a certain value and then levels off to a saturation value. For a small h.f. signal superimposed on V , the high dielectric constant ϵ , instead of remaining constant, falls off as saturation is approached; the high value and the non-linearity are most marked for temperatures in a range above and below the transition temperature T_0 , and it was shown how this temperature can be adjusted to be convenient by a suitable choice of material. Above T_0 , P shows no hysteresis loop, and so no hysteresis losses. Antiferroelectrics, such as some of the zirconates, show the dielectric anomalies without any hysteresis.

The change of a ferroelectric capacitance with temperature has been used for remote thermometry, while its change with bias V has been used for

The dielectric amplifier is analogous. With ferroelectrics the control is a voltage V_c which polarizes a piece of the chosen material, forming the dielectric of a capacitor C . The a.c. dielectric constant ϵ falls when the control voltage rises, i.e. C falls, and the rising impedance controls an alternating supply (Fig. 13), which may be an r.f. power supply, in a manner like that of the magnetic amplifier. The output may be demodulated if appropriate.

The supplies to both instruments are simple, there are no heaters, and other advantages over conventional amplifiers are simplicity, ruggedness, and cheapness. The dielectric amplifier may be cheaper than the magnetic amplifier, and it extends to a higher frequency range. It gives a mean power gain, and will respond to a d.c. control if required. Certain questions of temperature stability will probably be solved in time.

The magnetic amplifier attracted attention in the 1940s and was successfully applied to automatic control and measurement, in analogue computers and servos, and for supply stabilizing. The dielectric amplifier is younger. Potentially its applications are the same but it embraces also amplification at audio frequencies since there are no iron-loss limits, and it can work from a high-impedance control source; there may be places where magnetic and dielectric amplifiers can be used together, since the supplies may be similar. It has uses wherever a.f. amplification is needed, with pickups, for d.c. amplification, and in any electronic systems where modulation is an appropriate way of conveying a signal, and wherever power amplification of a small actuation is needed to operate a device, from transducers, in servo and relay systems, for stabilizers, remote controls, and thermostats.

The ferroelectric used has been sometimes ceramic and sometimes crystal, and the temperature used is sometimes below T_0 and sometimes above T_0 ; in practice it is the material which is selected, rather than the temperature. Various zirconates have been used, and barium strontium titanate. The hysteresis loop is not needed, and to some extent can be ignored; it is only the non-linearity that matters. So the primary reason for working above T_0 is to avoid the losses represented by the loop area; the large piezoelectric effects below T_0 also cause troubles. But because of the nature of the curves, better temperature stability can be got below T_0 . In either case the working temperature used is close to T_0 because there the rate of change of ϵ with control voltage is high, giving high gain. This rate of change depends not only on the temperature but also on the mean control voltage (Fig. 14(b)) so this will need to be suitably chosen. Thus the control voltage V_c is usually a static bias voltage and a signal (e.g. audio frequencies ω_c) (Fig. 13(b)), so that the gain referred to the a.f. depends on the bias, which is chosen to give the highest gain, subject to other specifications being

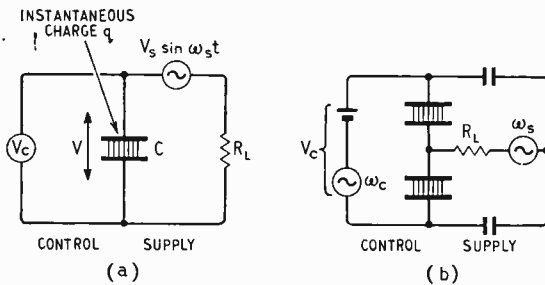

Fig. 13. Dielectric amplifiers

tuning in a superhet, and also for frequency modulation.

Dielectric Amplifiers.—The dielectric amplifier is a device which may be compared with the well-known magnetic amplifier; both are power amplifiers working well at low frequencies. It uses non-linear dielectrics, including ferroelectrics because they are strongly non-linear. In the magnetic amplifier a relatively slowly varying controlling current in a coil is used to magnetize the core to a greater or less extent. When the current is high, the core approaches magnetic saturation and its permeability falls so that the inductance L of the coil falls. This falling impedance causes an increase in an alternating supply-current (sent independently through the coil) in sympathy with the control. In practice, the supply-current may flow in a separate coil on the same core; as its amplitude rises and falls in a more or less faithful reproduction of the control, it is thus deeply modulated to correspond to the control. The only supply required is the alternating current, and possibly a steady current to bias the core suitably.

*Queen Mary College, London University.

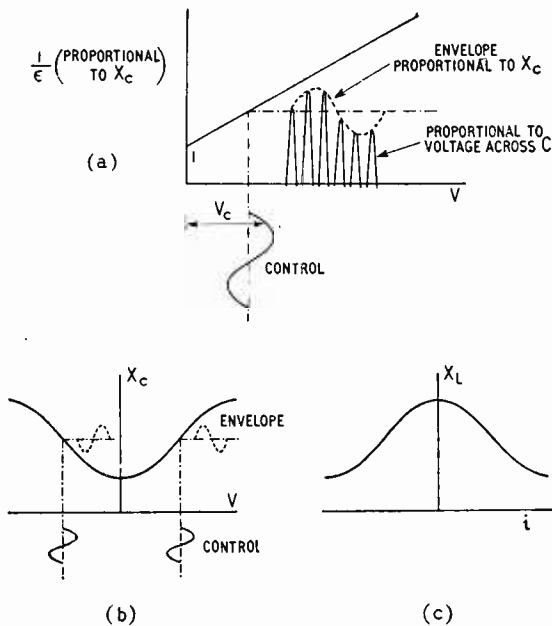

Fig. 14. (a) Simplified analysis: For large R_L , voltage across C in Fig. 13(a) is $X_c \frac{V_s \sin \omega_s t}{R_L}$ where $X_c = \frac{d}{\omega_s A \epsilon}$ (see Fig. 15). (b) More realistic curves. (c) Magnetic amplifier coil impedance curve.

also met. The rate of change of ϵ with V_c is higher for single crystal material, but this is probably more expensive to produce. Notice that if instead of $\omega_c < \omega_s$ we replace the a.f. by a "pump" at twice the supply frequency, we find we have returned to "Cathode Ray's" analysis of Mavars in the May issue.

The ϵ depends on temperature, mean voltage, and frequency. Operation is stable only if the temperature is constant. If voltage swings used are large enough to traverse the loop, the heating caused by the loop loss will make temperature stability difficult; the effect increases with and is proportional to the frequency. Circuit analysis is done assuming constant T and, often, implicitly assuming ϵ does not change with frequency. This assumption will also serve us here; it will let us examine the basic ideas in a simpler form than would a full analysis. For suppose the P-E curve

of the ferroelectric were $P = \frac{1}{a} \log(1+aE)$ for positive E, a representation adopted here merely for simplicity. Then ϵ , measured by a small signal of relatively low frequency, at the biased point B (Fig. 15), is the slope of the curve, $\epsilon = 1/(1+aE)$, and the assumption of frequency independence allows us to use this also for ϵ at higher frequencies. Then Fig. 14(a) shows how X_c , the impedance at supply frequency of the ferroelectric capacitor, could be used to give an output. In practice, the impedance varies a current. The sensitivity limit is set by noise due to the domain movements.

Notice that Fig. 14(a) does show the non-linearity; if there were none this line would be horizontal. But it is an idealized version of a curve shown more realistically in Fig. 14(b), which may be compared with the coil-impedance curve in the

magnetic amplifier, Fig. 14(c). A single stage can be used with or without phase inversion, depending on the polarity of bias chosen. It is possible to provide the bias by feedback from the output in suitable cases. With zero bias, frequency doubling of the envelope would occur.

Analysis.—Circuit theory falls as usual into two parts: (1) the construction of the differential equation describing the circuit, and (2) finding the solution of the equation. When the circuits are non-linear, the differential equation is non-linear, and usually cannot be solved exactly. What is more, the equation itself is usually not an exact description of the circuit, because it depends on some mathematical representation of the non-linear curve (the valve or transistor characteristic, the core saturation characteristic, or the P-E curve of the ferroelectric); the representation is chosen to be a good fit to the experimental curve, *subject* to its giving an equation we can solve. The solution of the equation can then be given as an expression for the output current or voltage in terms of the circuit values and the supplies and frequencies. The way we choose to approximate to (2) depends to some extent on the representation chosen for (1). But the first step is usually to replace the non-linear curve of Fig. 15 by the dashed line. Notice first that in drawing this figure we are ignoring the hysteresis loop if we are working below T_0 , and that further the dashed line is a good approximation only when V_c is near zero (a zero bias plus a sufficiently tiny signal).

For example, to the simple circuit of Fig. 13(a) add a resistor R associated with the control V_c . Consider first that V_c is bias only; later this type of analysis will very readily serve for the more general case of bias plus a.f., provided that ω_c is much lower than ω_s . The governing equation can readily be found in terms of q and V:

$$\frac{dq}{dt} + \frac{V}{R^1} = \frac{V_c}{R} - \frac{V_s \sin \omega_s t}{R^1}$$

R^1 is the parallel combination of R and R_L . Into this equation substitute the chosen representation of the curve of the ferroelectric, that is V as a function of q. The first approximation is the ordinary linear equation got by substituting q/C for V (C here corresponds to the dashed slope), giving the steady state solution:

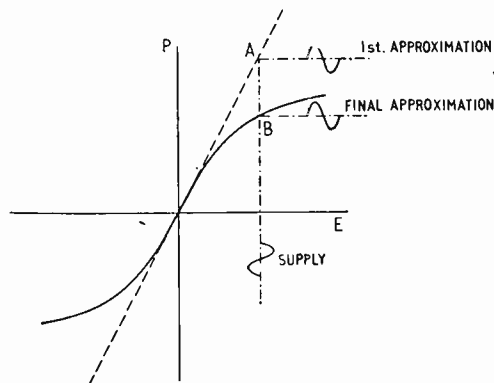

Fig. 15. The non-linearity. The $q-V$ relation needed in the analysis is a scaled version of this figure, with $q = PA$, $V = Ed$, where q, A, d are respectively instantaneous charge, area, and thickness, of the ferroelectric capacitor C

$$q = \frac{V_c}{R} - \frac{V_s \sin \omega_s t - \phi}{R_L \sqrt{1 + \omega_s^2 \tau^2}}$$

with $\tau \equiv R'C$, $\tan \phi \equiv \omega_s \tau$. The term $\frac{\tau V_c}{R}$ is the mean

charge on the ferroelectric capacitor due to V_c , and corresponds to point A in Fig. 15. The whole expression gives the supply waveform marked "first approximation" in that figure. If we project that waveform into the one marked "supply", using the dashed line, and back into "final approximation," using the curve, we are graphically simulating what the second and succeeding mathematical approximations must do. Each stage of approximation is used in getting the next, though the manner in which this is done depends on the method chosen. Finally the current comes from differentiating q .

It has already been pointed out that this form of analysis, in which l.f. and h.f. relations are represented in the same q - V curve, is using an unwarranted assumption of frequency independence. For better analysis, the h.f. curve may be obtained for any given ω_s by measuring the ferroelectric capacity at ω_s under varying bias V . Each point on the curve is then given by

$$q = \int_0^V C dV.$$

A capacitor C_B inserted in the supply branch of Fig. 13(a) prevents R_L from reducing the bias applied to the ferroelectric from the control branch V_c , and a suitable inductance in the V_c branch keeps the supply frequency out of the control circuit. But the inductance may not be needed if two ferroelectric capacitors are used as in Fig. 13(b), for now no component of ω_s (or its odd harmonics) appears across V_c . The gain is less. The power gain falls off steeply as the control frequency rises, but may be increased by using a higher ω_s .

The voltage gain is less than one; in fact it is clear that the fractional variations in output current cannot exceed those in $1/X_c$, so in ϵ (Fig. 14). So there is interest in the resonant amplifier. One form of this may be derived by tuning the capacitor C_B mentioned above; this is practicable only if the temperature stability is good. Let us write C' for the value of the ferroelectric capacitance C at resonance, and C_T for the series combination of C' and C_B . With a series tuning inductance L_T in the supply branch, the resonance condition is $\omega_s L_T = 1/\omega_s C_T$ for a small enough supply voltage. The modulations in the supply output may now be thought of as due to the audio control-variations, which swing it off tune. It has been shown† that

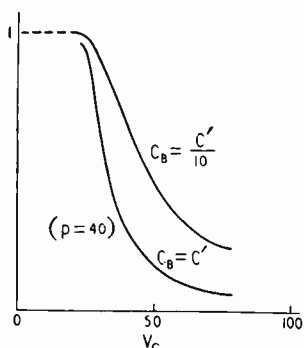

†A.I.E.E. *Trans.*, Pt. I, 72, 68, 1953. G. W. Penney, J. R. Horsch, E. A. Sack.

Fig. 16. Detuning characteristic for a resonant dielectric amplifier† (see text)

the fractional variation in output supply-current amplitude is then multiplied by

$$\sqrt{1 + Q^2 \left(\frac{C_B}{C} \cdot \frac{C' - C}{C' + C_B} \right)^2}$$

where Q is $\frac{\omega_s L_T}{\text{loss resistance}}$, analogous to linear circuits

if the supply voltage across the ferroelectric is small; the loss resistance is the sum of the resistances associated with C_B and with L_T and with the ferroelectric. The reciprocal of this multiplier plotted against V_c falls off steeply from 1 as V_c is increased from zero, and has been called a detuning characteristic (Fig. 16). For the voltage amplifier, the bias will be adjusted to the point at which this curve has the greatest slope G . Output voltage may be taken from a demodulator across L_T .

Actually if the supply branch losses are not too great C_B can be made quite small without appreciably

altering $p = \frac{QC_B}{C' + C_B}$ in the above multiplier, because

Q increases to compensate the decrease; at $C_B =$

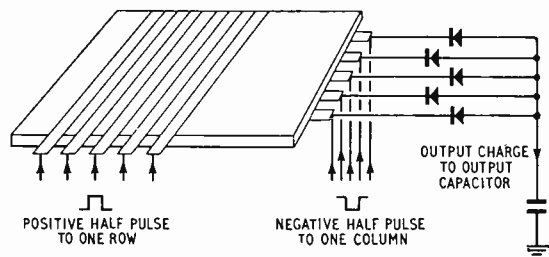

Fig. 17. Matrix electrodes on ferroelectrics

$C'/10$, G was only spoiled† by a factor of about 3 (Fig. 16). These small C_B values are of use in voltage amplifiers, in which the changes in the resonant voltages across L_T or C_B are made to exceed the control volt changes. For as C_B decreases, the resonant supply r.m.s. voltage v across the combination C and C_B (which equals that across L_T) increases in relation to the supply volts across C , so the changes across L_T increase. The voltage amplification is $\sqrt{2} Gv$. At $C_B = C'/10$, v had multiplied by 11, giving amplification about four times better than without tuning.

Working below T_0 , and using crystal material because the loops are steeper than in ceramics, supply frequencies up to a few megacycles are possible. Supply amplitudes which are not small compared with the saturation voltage for the crystal have been tried; in this case, the analysis of Fig. 14 is not valid. 12 dB power gain has been quoted, over a 7-kc/s band, using 1/10-mm electrodes on a barium titanate crystal. Very much larger gains have been quoted in bridge circuits. Heating and other factors set the frequency limit.

Computer applications.—Digital computers use a large variety of two-state devices and fast switches, built into the form of memories, registers, counters, selection gates, and so on. In the early days, the classic flip-flop circuit formed by a double triode was used for many of these, but there has been a continuing search for new devices which are cheaper,

(Continued on page 461)

faster, cooler, more robust, and more convenient.

J. R. Anderson suggested in 1952 that ferroelectrics with good square hysteresis loops might be used as stores ("memories"). Each cell of a store holds one binary digit (bit), whose two possible values or states are conventionally called "0" and "1". So the cell must be able to take up either of two states in response to the right one of two different stimuli ("writing") and it must be able, when "asked," to indicate which state it is in ("reading"). Nothing else is strictly necessary, so there is in principle an enormous number of possible storage devices. It is the extra requirements that determine which of these are developed and used.

If the states are permanent when the stimuli are absent, equipment for continual regeneration of the store contents will not be needed, as it is, for example, in the cathode-ray tube store. It is often convenient if the reading process is "non-destructive" of the stored value; it is not so, for example, in the simple form of ferrite store, so there must be circuitry to restore the previous contents of a cell by a "writing" process each time it is consulted. The enormous speed of modern digital computers means that the cell must respond very rapidly, say in a microsecond. It should be small, but one should examine the size of the cell *plus* an appropriate fraction of its circuitry. It should be cheap and this implies that the advantage would be with any cell which could be mass produced and did not need too elaborate circuitry. A cell costing threepence (with its circuitry) will give a store of 10,000 forty-bit words for £5,000.

The speed of a computer is not limited by the response time of the cell, but more often by the time taken to get access to the required cell. Which cell is needed, at each instant, is shown by its "address" number in a register somewhere in the computer. This register sets up switches to select the right cell, and this setting-up can take a relatively long time. It is here that square-loop devices such as ferrites and ferroelectrics come into the picture, for they can be used in a matrix store, where effectively part of the selecting is done in the cells themselves. It may save time if there is less external switching to be done. It will certainly need less external circuitry. For the cells are here arranged in a matrix of rows and columns in such a way that instead of one external selector for each cell, only one for each row and column is needed. In our £5,000 store, if the cells corresponding to, say, the 3rd bit of each "word"† are in a 100 × 100 matrix only 200 selectors are needed instead of 10,000 for the 3rd bit. If half the threepence was the cost of the selectors, all the selectors now cost only £50.

The principle of matrix selection is that the "read" impulse is halved in magnitude and applied at the same instant to the row and column crossing the required cell. That cell receives the sum of the halves. Only that cell gets an impulse of full magnitude and so responds by indicating what is its state; that is, it gives an output pulse. Most other cells get no impulse, but some others do get a half-size pulse. It is essential that the properties of the cell should be such that a half-size impulse has no effect, or, strictly, that any output resulting from it is small enough, or short enough, or slow enough to be easily distinguished from the

output due to a full-size impulse. This can be done with cells made of materials which have "square" hysteresis loops, such as ferroelectric barium titanate crystals or the analogous magnetic materials such as ferrites. But the requirement is very stringent, for two reasons: (i) the output is often received on a circuit which is common to all the cells, so it is the *sum* of, say, 198 unintended signals which must be negligible; (ii) production of the unintended signal by an unselected cell may also slightly alter the stored state of the cell, and a cell which is not intentionally consulted often must be able to withstand possibly many thousands of these half-size impulses without noticeably altering its state, unless we are prepared to provide regenerating circuitry. On this second count, at present, ferroelectrics do not appear satisfactory, and there is also an ageing effect which is not understood.

In ferrite stores, each cell is a tiny ring of the material. One of the "row" wires and one of the "column" wires passes through each ring. One "output" wire threads them all. Half-size current "reading" pulses are applied to the selected row and column wires. These add in the one selected ring, and reverse its magnetization; an induced current pulse will then appear on the output wire if that ring held a "1," say. By analogy, if a set of parallel "column" strip-electrodes is deposited on one face of a ferroelectric crystal, and "row" strips on the other face (Fig. 17) the square segment of material between one of each set constitutes a cell. The direction of the ferroelectric axis must be arranged to lie through the thickness of the crystal. Reversal of one cell does not affect its neighbours; there is no stray field. A half-size voltage pulse is applied to a row electrode and a negative half-pulse to a column. One cell is thus subjected to a full-size pulse. If it held a "1" say, its polarization is reversed and output charge appears (Fig. 18(a)) which can be used as a current pulse or as a voltage pulse on an output capacitor. An experimental matrix has been made in this laboratory with ½mm electrodes at about 800 cells per cm². The pulse generators must have sufficiently low imped-

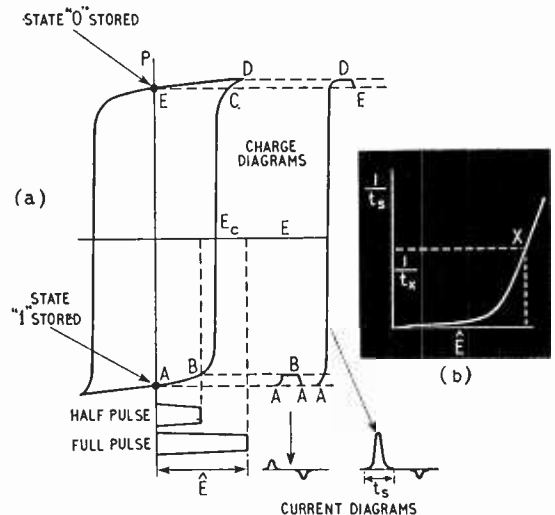

Fig. 18. (a) Polarization changes and currents resulting from a half-pulse (ABA) and a whole pulse (ABCDE) applied to a cell storing "1". \hat{E} and t_s are defined in this figure. (b) Speed of reversal for various pulse sizes

†Thirty to forty bits make up one "word," on which arithmetic operations are to be performed.

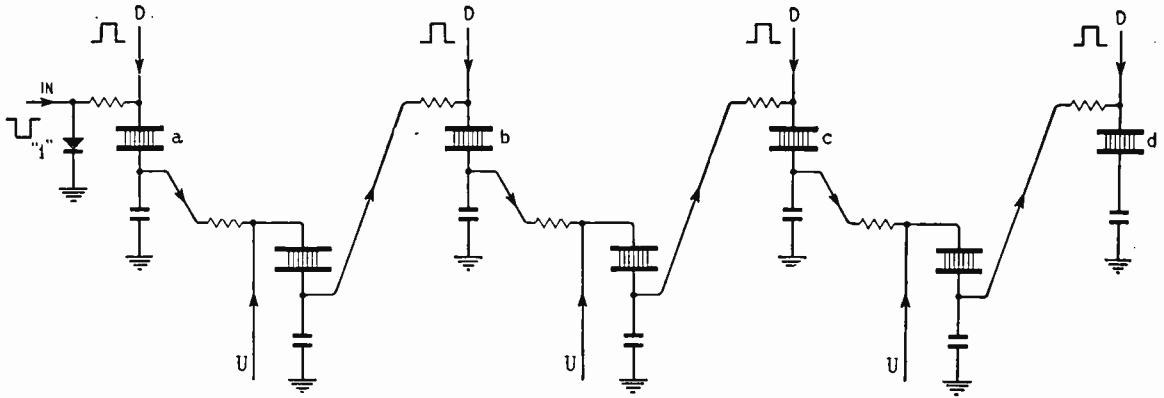

Fig. 19. A shifting register (schematic)

ances for speed; the reversal of 26 microcoulombs per cm^2 in, say, 10 microseconds using electrodes of area $1/10$ sq. mm releases a mean current of 5 milliamps. The loop area indicates a heating effect of about a milliwatt per cell at 10kc/s p.r.f., but it is not difficult to cool the crystals sufficiently.

A "square" loop is wanted for this application so that the different action of half and full pulses shall be sharply demarcated. The previous article showed why barium titanate crystals have a square loop at reasonable frequencies. The polarization is all in directions parallel or antiparallel to the external field through the crystal thickness, and there is apparently a greater barrier to the start of the reversal process than to later domain motions. **Matrix Speed.**—Now the loop of Fig. 18(a) was traced at a frequency appropriate to the intended application; it cannot show time effects. The reversal time depends on the magnitude \hat{E} of the reversing pulses as shown in Fig. 18(b). Their duration must be longer than this time. The decision to use matrix selection fixes the \hat{E} to be used; that is the full size of pulse cannot be greater than about $1\frac{1}{2} E_c$ (only 10 to 20 volts on $1/10$ -mm crystals). On Fig. 18(b), E_c is about where the elbow is, so the maximum speed is given at X. With the present materials it is not faster than about 10 microseconds. Escape from this limit must be either by abandoning the economy of matrix selection or by modifying the material so that the main slope of Fig. 18(b) is steeper. But if this reduces E_c in the same proportion nothing will have been gained.

Fig. 18(b) also demonstrates the point (ii). For fields less than E_c will overcome the activation barrier if given time. And though the figure shows it would take a very long time (say $50,000 t_a$) for a half-size field to reverse barium titanate, it has been found that the process is cumulative, so that a large number of the computer half-pulses will eventually cause complete reversal. Modified forms of matrix reduce the problem.

Other Devices.—So at present the need for occasional regeneration offsets the advantages of compactness, easy construction, and voltage operation. It may be that the future for barium titanate lies rather in shifting registers and counters, which are not subject to the matrix speed limitation. With a small output capacitor, the output voltage from one cell can drive another directly. Now a string of "0s" (say, positive pulses) written into the one

cell gives no output until after a "1" has been slipped into the sequence, because no reversal occurs. Then if it can be arranged that the output corresponds to a "1," it can be propagated down a line of cells, as in a shifting register. Because the output from a reversed ferroelectric cell has the same polarity as the input this means the sign convention must be changed between successive cells. In Fig. 19 a "shift" operation consists of writing "0s" first into all the upper cells at DDD and then into the lower at UUU. If an input bit "1" has been written into the cell *a* in advance, the shift moves it into *b*, and so on. If we adopt for cells *a*, *b*, *c*, . . . the same sign convention as in Fig. 18(a) (positive pulse writes "0") the opposite convention is needed for the lower cells, so the shift pulses *U* are negative. So the unit operation takes three time intervals; input of "1" or "0" at *a*, shift down, shift up.

Such registers have been built using barium titanate crystals and with transistor drives. Ceramics have also been used, even for stores, and methods for non-destructive reading of stores have been tried. One of these uses the alternating signal generated piezoelectrically when a cell is vibrated by ultrasonics. The loop need not be square for reading. The piezoelectric coefficient changes sign with *P* (see previous article) so this output has an opposite phase according to the direction of polarization; very fast operation does not seem possible. Another computer use for ferroelectrics is in the form of bistable elements called ferroelectric resonant pairs, by analogy with the older "ferroresonant pair" which uses a variable inductance and will trigger easily at 20-kc/s rate. The ferroelectric resonant pair should be faster. It uses again the non-linearity of a ferroelectric capacitor *C*. One form has in parallel, across a source $E \sin \omega t$, two series resonant circuits each made of a linear *L* and non-linear *C*. The resonant conditions in non-linear circuits depend on the current amplitudes. It has been shown that with *E* small, ordinary linear resonance can occur in the two branches. But with suitable circuit values there is a range of values of *E* for which this mode becomes unstable, and gives way to a non-linear resonance in which the charges flowing on one branch are much larger than those in the other. Either branch may take the larger current, and windings on *L* will allow triggering from one non-linear resonant state into the other.

Ferrite-Cored Aerials

By "CATHODE RAY"

HOW THEIR EFFECTIVENESS DEPENDS ON THEIR SHAPE

DURING the last few years there has been quite a revolution in broadcast receiving aerials. Unlike some revolutions—for example those in Caribbean politics, but especially more vital matters such as hem height—it has received scanty publicity.

It seems not long since broadcast receivers fell mainly into two classes: the larger one consisting of mains-powered sets occupying a permanent position in the home, and the smaller (in numbers and size) battery-driven portables. The first lot had a socket for connecting a wire aerial, and usually some arrangement for the alternative (and, human nature being what it is, the practically invariable) use of a "mains aerial"—a connection via a small capacitor to the power flex so that it and the house wiring fed to the r.f. input such signals as they picked up. The fact that they formed an excellent channel for electrical interference was such a fruitful source of complaints by the listening public that it gave rise to the "Cathode Ray" Course on How to Become a Radio Expert in Ten Seconds (positively no intelligence needed). All one had to do, without even waiting to hear the details of the trouble, was to advise the patient to substitute an outdoor aerial for the "mains aerial." This worked like a charm in 90% of cases, and one could always talk oneself out of the remainder by murmuring a few technical phrases at random.

The second lot—the portables—were provided with a frame aerial, which had to be reasonably large to give an acceptable performance, and thereby limited the smallness to which the sets could be designed. And because these aerials inevitably embraced within their magnetic and electric fields all the miscellaneous materials forming the rest of the set, they inevitably had rather a poor Q.

But now all that has been abolished, and it is standard practice in both classes of receiver to use a ferrite rod aerial. For a given receptivity it is much smaller than an air-cored (?) frame aerial, so is a very timely development in these days of transistors, making possible loud-speaking superhets that hardly bulge the breast pocket. And because their windings have an internal diameter of less than half an inch, their external fields are confined and the designer has far more control over Q, etc. So their advantages for portables are obvious.

Seeing however that the aforementioned human

nature (and especially feminine human nature) is intolerant of any kind of external aerial, ferrites have likewise swept the board in mains-driven sets, where they provide a generally adequate signal pick-up without the crackle-and-bang accompaniment typical of the "mains aerial."

To the ordinary moderately technical type who is supposed to be reading this (my apologies if the description insults you) two questions are likely to occur. Why is the ferrite core always long and thin? And how does it enable such a small coil to pick up as much as a far larger one without the core?

I could of course short-circuit this article by answering both at once with the reply to the second: "Because it is long and thin." But that will hardly satisfy you if you have in mind that the signal voltage picked up by any coil aerial is proportional to the number and size of its turns of wire, and a ferrite aerial not only has very small turns but also not very many of them. Presumably the advantage of the ferrite lies in its high permeability concentrating the signal flux through the turns of the coil so that each turn picks up far more signal than the same sized turn in air, but how is it that this same permeability doesn't cancel out its own advantage by reducing the number of turns for the required tuning inductance?

Persons of my own limited intelligence have to begin by considering why it is that making the ferrite core long is an advantage. How do the end parts, situated so far from the coil, make themselves useful?

We shall assume first of all that the distant transmitter is providing at the receiving end an oscillating magnetic field which at any given moment is uniform over a space much larger than the aerial. (This is fair enough, because even the shortest waves in the medium band are about 200 yards long, so their magnetic flux density is practically the same everywhere within a yard or so of the aerial.) Such a uniform field is depicted in the conventional way by imaginary lines of force as in Fig. 1. We are supposed to be looking towards the transmitter.

Our second assumption will be that the permeability of the core material is so large that its reluctance—magnetic analogue of resistance—is negligible. (This also is fair enough, because the ferrites used have a permeability of the order of 200, so their reluctance is less than 1% that of air.)

A line of force will therefore not hesitate to go out of its way and thereby increase its air path if necessary by several inches if by doing so it can elsewhere save a rather larger number of inches by passing through the ferrite. If however the ferrite inches are at right angles to the original run of the lines, there is no advantage in turning aside. In Fig. 2 a thin ferrite plate has been so placed, and the field could hardly care less. So a core of this shape, placed inside the turns of a frame aerial orientated

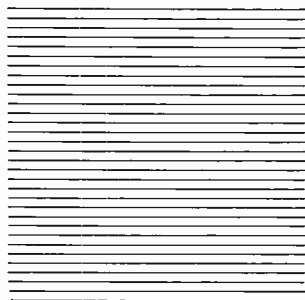

Fig. 1. Conventional representation of a uniform magnetic field by a series of equally spaced parallel straight lines.

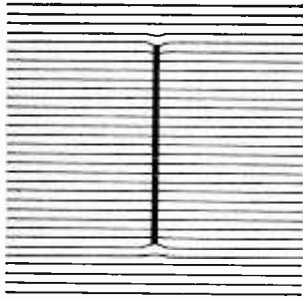

Fig. 2. A thin sheet of high-permeability material offers hardly any scope for the flux lines to take an easier (lower-reluctance) path, so barely affects their routes at all.

to embrace the maximum magnetic flux, would be useless.

Fig. 3, by contrast, shows what happens when the ferrite is placed in line with the flux. In case the various distortions of the lines are not self-explanatory, imagine that the spaces between lines are electrical conductors all carrying equal currents in parallel between the same difference of potential across the width of the diagram. Therefore each conductor must be so shaped as to have the same resistance. The relatively large magnetic reluctance of the air can be represented by highly resistive material such as water, and the negligible reluctance of the ferrite by the negligible resistance of metal.

The flux lines near the axis of the rod can pass through its whole length with very little increase in their path length; the resulting great saving in distance through air must be offset by narrower air paths; in other words, the lines crowd together to give a high flux density. Those farther off the axis have to add appreciable air length to take advantage of a ferrite path, so the narrowing of the inter-line spaces is less marked; this forces the lines out of the end parts of the rod. But lines over quite a large cross-sectional area—comparable with that embraced by a conventional frame aerial—pass through the centre part of the rod.

Note that there is some increase in lengths of lines which enjoy no rod path at all; their gain lies in their wider spacing. Some of these lines bend sufficiently to make themselves useful by coupling with at least the outer turns of a coil around the middle of the rod.

Thinking diagrammatically thus, we can draw several conclusions. First and most important, the rod gathers to itself flux that would otherwise need for its embracing a coil of diameter comparable with say half the length of the rod. This flux is thus brought within the scope of a coil of diameter little more than the diameter of the rod, making the aerial much more compact. That answers the question why the rod is long and thin.

Next, the maximum rod flux density is in the centre, tailing off towards each end. So the natural place to put the coil for maximum signal pick-up is at the middle of the rod. We might also conclude that the coil should be short and concentrated in shape, but we would be unwise to do so without more thought.

The factor by which the flux density across the centre of the rod is greater than in empty air is called (rather loosely, I think) the rod permeability or effective permeability, μ_r . As one would guess, it is less than the true permeability μ measured with a closed magnetic circuit, but tends towards that value as the ratio of length to diameter (l/d) of the rod tends to infinity—Fig. 4. A typical value

of l/d is 20; if μ is 200, μ_r is then 100, which also is typical. Incidentally, this is what μ_r would have worked out to be according to our rough guess that the rod might collect as much flux as an air-cored coil equal in diameter to half the rod length; with $l/d = 20$, the ratio of coil diameters would be 10 and the ratio of coil areas 100. But that is either a happy accident, or (you will say) low cunning on my part. Even for other values of l/d , however, the order of magnitude is right, and that is the most we had hoped for.

And now we come to the second question: how is it that the permeability of the ferrite doesn't largely destroy the advantage of increased flux pick-up by reducing the number of turns for a given inductance? The inductance of the aerial coil is indeed "given," by the broadcasting frequency band and the tuning capacitor, which are in no way altered by the use of a ferrite core.

For any particular shape of coil, its inductance is proportional to n^2d , where n is its number of turns and d its diameter. By the use of a core, as we have seen, the same signal flux (and therefore signal voltage) per turn can be picked up by a coil reduced in cross-sectional area by the factor μ_r . So its diameter is divided by $\sqrt{\mu_r}$. If the inductance of the coil were not affected by the presence of the ferrite, it would have to be kept to the same figure by multiplying the original n^2 by $\sqrt{\mu_r}$. The original number of turns, n , would therefore have to be

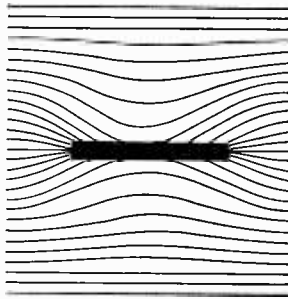

Fig. 3. If the material is placed end-on, however, much of the flux finds it worth while to turn aside in order to get the benefit of its lower reluctance

multiplied by $\sqrt[4]{\mu_r}$, a typical value for which is $\sqrt[4]{10}$ or 3.16. So besides reducing the aerial coil in size, the core would raise the total signal voltage induced in it by this factor. Which of course would be grand. But, as your keen intellects perceived from the outset, probably illusory on account of the effect of the core on inductance.

As Fig. 5 shows, the flux path around the coil is mostly through air, and one might take hope from the thought that however high the permeability of the core material it could hardly make much difference to the flux set up by a given coil current (which is what determines its inductance). Perhaps a two-fold increase, at most. But it must be noted that the flux lines have far more elbow room in the air part of their paths than in the core, so in actual fact the core occupies what would otherwise be responsible for as much as nine-tenths of the total magnetic reluctance. Assuming that the ferrite's permeability is large enough for its reluctance to be neglected, we see that nine-tenths of the total reluctance is removed by the core, leaving only one-tenth.

The number of turns must therefore be adjusted to divide the inductance (multiplied ten-fold by the core) by 10. Since the inductance is proportional

Fig. 4. How the ratio of length to diameter (l/d) of ferrite rod with permeability μ determines its effective permeability μ_r , as regards surrounding magnetic fields. (After H. van Suchtelen, *Electronic Application Bulletin*, Vol. 13, No. 6, p. 88.)

to n^2 (other things being equal) this means dividing the number of turns by $\sqrt{10}$. Which, in this particular case and with the assumptions stated, just cancels out the illusory advantage, leaving us with a small ferrite-cored aerial exactly equal in signal pick-up to the coreless aerial 10 times larger in diameter.

You may remember my advice to suspend judgment on whether or not to wind a coil concentratedly as in Fig. 5 in order to take advantage of the maximum core flux density being confined to the middle of the rod. It is certainly obvious from Fig. 3 that spreading the winding out along the rod results in the average flux embraced per turn being less. But on the other hand this change of coil shape causes the number of turns required for a given inductance to go up. At first, the loss of flux per turn is more than offset by the greater number of turns, so the total signal is greater. On the other hand the larger number of turns is likely to make the Q go down, so the problem becomes rather complicated. If the coil is spread over more than about half the rod, its performance does decidedly fall off. Most of the coils one sees in sets are somewhere between the concentrated Fig. 5 and the fully wound rod.

This design problem may be further complicated by use of the same aerial rod for more than one waveband, and for extra coupling coils for optional external aerial, and as a step-down transformer to a transistor input.

The factor by which the inductance of the coil is increased by the core is another kind of so-called permeability—the coil permeability, μ_c . Obviously it tends to fall off slightly if the coil is slid along towards either end of the rod, and that fact is sometimes utilized for adjusting the coil inductance precisely to the designed value.

We have seen that in a typical example this disadvantageous μ_c is of the order of 10. It is obviously not going to be appreciably increased by ferrite

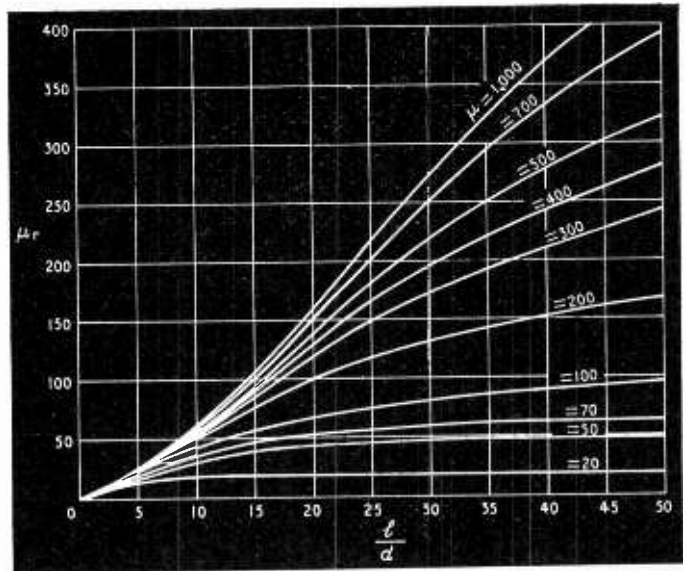

located far from the coil; in other words, increasing the length of the rod, which increases the beneficial μ_r approximately in proportion, has negligible counteracting effect, so is all to the good. It enables μ_r to be much larger than μ_c .

In brief: To a first approximation (taking no account of change of coil shape) the use of the ferrite rod enables the diameter of the coil to be divided by $\sqrt{\mu_r}$ while retaining the same signal voltage per turn. But for the same inductance the number of turns (and hence the total voltage) is increased because of the reduction in diameter, and reduced because of μ_c . The combined multiplying factor $\sqrt{\mu_r/\mu_c}$. In our example, μ_r happened to be equal to μ_c^2 , causing this factor to be 1 and therefore to make no difference. The shape of coil (as compared with a frame aerial) is usually longer in relation to diameter, putting up the number of turns and therefore the signal voltage; but this advantage is reduced or even reversed by the smaller pick-up per turn away from the centre of the rod, and by the probably lower Q.

If you insist on having it in equations, here they are, in m.k.s. units. The r.m.s. voltage induced in an air-cored coil of n turns, each enclosing an area of A square metres at right angles to a magnetic field producing a flux density in air of B_a webers/m alternating at $\omega/2\pi$ c/s, is

$$e = \omega B_a A n \dots \dots \dots (1)$$

If the coil is ferrite-cored, B_a is thereby multiplied by μ_r :

$$e = \omega B_a \mu_r A n \dots \dots \dots (2)$$

As compared with (1), A is likely to be made smaller in about the same ratio as $1/\mu_r$, giving about the same e per turn. To take account of n we assume that the inductance L is a constant, and make use of the relationship

$$L = k \mu_c d n^2$$

where k is a shape factor, d the diameter in metres, and μ_c the effective permeability of the core as regards the inductance of the coil. This gives n in terms of L , for substitution in (2):

$$e = \omega B_a \mu_r A \sqrt{\frac{L}{k \mu_c d}}$$

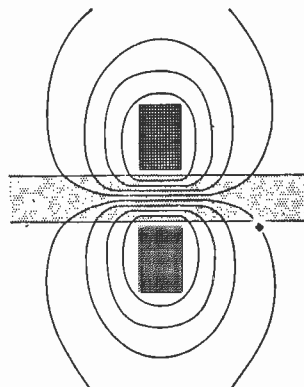

Fig. 5. Typical flux paths due to current in concentrated coil with ferrite rod core.

Since $A = \pi d^2/4$, $d = 1.13\sqrt{A}$, so

$$e = \omega B_a \mu_r A \sqrt{\frac{L}{1.13k\mu_c\sqrt{A}}}$$

This can be clarified by bringing together within a bracket the things we are regarding as constant so far as aerial design is concerned:

$$e = \left(5.9fB_a \sqrt{\frac{L}{k}}\right) \frac{\mu_r A}{\sqrt{\mu_c} \sqrt{A}}$$

In our example, μ_c happened to equal $\sqrt{\mu_r}$, so the denominator was $\sqrt{\mu_r A}$ and on the assumption that $A = 1/\mu_r$ the result was the same amount of e as from an air-cored coil embracing the same total flux.

The voltage across the coil, used as a tuned circuit, is Qe , and when amplification is by valve that is usually the signal voltage available for it.

And that is as far as we are going with these receiving aerials. But in case anyone has been perplexed by reports that ferrite rod aerials are being used for microwave transmitters, I will end with a few notes to show that any similarity these may bear to what we have just been considering is purely coincidental. Their mode of operation is entirely different. These rods are in fact being used not so much for their permeability as for their permittivity or dielectric constant (ϵ), which, at about 9,000 Mc/s. (X-band) is as much as 14. Their relative permeability (μ) on the other hand, is only about 0.75. At lower

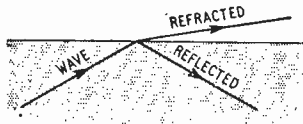

Fig. 6. How a radio wave travelling at an angle inside a dielectric rod is partly reflected and partly refracted at the surface.

frequencies it is of course much higher, and comes in very useful in a secondary role, as we shall see.

The usual non-mathematical method of explaining how waveguides work is in terms of waves zig-zagging along the guide, like a drunk man in a narrow passage, with repeated reflections from side to side. At a certain angle (depending on the wavelength) the wave pattern is a possible one; that is, the electric field is continually zero everywhere along the inner metal surfaces. So there is wave motion along the guide but none outside it. Reflection from the metal surfaces is complete.

When, on the other hand, electromagnetic waves reach a boundary between two non-conducting media—such as glass and air—part of the wave is reflected and part goes through but is bent or refracted from its original direction, as in Fig. 6. All this can easily be seen by experimenting with light waves passing from water to air or vice versa. The angle of refraction depends on what is known in optics as the refractive index (better known to us as $\sqrt{\mu\epsilon}$) of one medium relative to the other.

So a solid rod of dielectric material acts to some extent as a waveguide, but with the difference that as the wave travels along the rod more and more of it is transferred to the surrounding air and at the same time directed more forward. The resultant of all the escaping components, allowing for their phase differences, is a beam radiated in the direction in which the rod is pointing. The longer the rod, the narrower the beam.

It has been found that for the X-band, in which the waves are a little more than 3 cm long, good results are obtained with rods about 12 cm long and

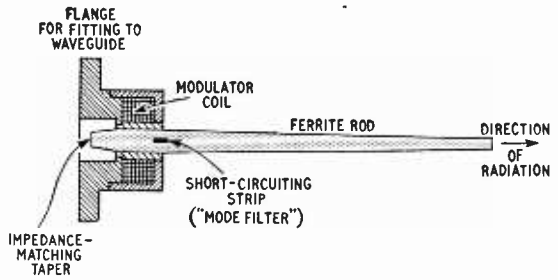

Fig. 7. Section of X-band ferrite-rod transmitting aerial.

0.6 cm thick. To prevent the radiation of side lobes, the beam is tapered to a small diameter at the far end. Waves are launched into the thick end from a waveguide, as shown in Fig. 7. Narrower pencil beams, or fan-shaped radiation, can be produced by parallel arrays of these radiators, as in conventional beam aerial practice.

Even if that were all, it would be a very neat and convenient device. But the low-frequency magnetic property of the rods is utilized too, enabling the beam to be switched on or off, or modulated, or its beam scanned or the polarization of the waves rotated simply and economically without moving parts. This is thanks to the Faraday effect, which is the name given to rotation of the plane of polarization of waves by a magnetic field. Such a field is produced by passing current through the coil shown in section in Fig. 7. Only about 10 mA is needed to rotate the polarization through 90°. By short-circuiting the waveguide from side to side by a metal strip through the ferrite rod, the waves are "turned off" when the plane of polarization is changed from perpendicular to parallel to this strip. This is one of many neat control systems that have been devised. "Elegant" is the word that comes to mind for summing up this composite application of the properties of ferrites.

Electronic Chronometer



This marine chronometer, accurate to 15 sec in one year, is produced by the Sperry Gyroscopic Co. Output from a temperature-controlled crystal oscillator is divided to 50c/s by locked oscillators and output is available at 2 p.p.s. for slave clocks.

Transistors and printed-wiring boards are used and various ships' main supplies are provided for; power consumption is about 6W and accumulators provide emergency power supply, to which switching is automatic.

Designing a Transistor Receiver

2.—R.F. Amplifier and Aerial Stage

By T. SNOWBALL

(Concluded from page 370 in the September issue)

IN the September issue we discussed the design of the receiver by working backwards from the loud-speaker to the detector stage. It now only remains to carry the procedure on to the aerial stage.

The R.F. Stage.—The author decided to use an r.f. stage in order to give the set enough sensitivity on an internal aerial and to permit the diode detector to work on a linear part of its characteristic curve when tuned to local stations. An r.f. transistor stage covering 200kc/s to 1.5Mc/s, using a transistor which is not too expensive, means a carefully designed stage in order to get a good proportion of the available gain. To get the maximum gain the input tuned circuit must be matched to the input impedance of the transistor, and also the transistor output impedance must be matched into the following stage input impedance. In a matched case like this a theoretical gain of approximately 45dB can be obtained with an OC44, but due to an internal feedback path equivalent to 10pF and 3k Ω the stage will probably oscillate. It is therefore advisable to neutralize the internal feedback by means of an external path. When both the real and imaginary parts of the feedback are completely cancelled the process is known as unilateralization.* When the r.f. stage is perfectly neutralized the maximum gain expected, with no circuit loss, is shown in Fig. 9. But of course over the frequency range 200kc/s to 1.5Mc/s the internal parameters of the transistor change, the neutralization will not be perfect, and some feedback will occur. About the only way out of this situation in a production run would be to reduce the gain of the stage, such that the product of forward gain and feedback path attenuation is one quarter. This is the long way of saying that

* "The Junction Transistor and its Applications" E. W. Wolfendale, p.163.

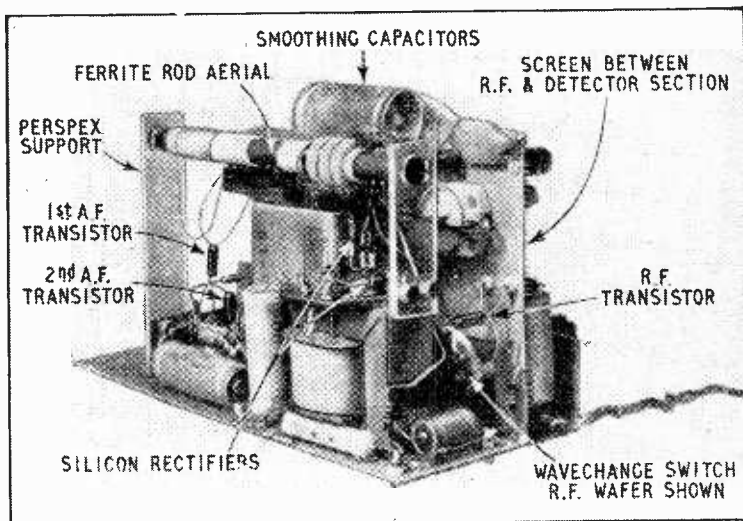

Rear of the chassis showing the mains transformer and principal components.

the loop gain is made $\frac{1}{4}$, or a stability factor of 4 is achieved. This method should certainly be adopted in a production set but inevitably, in order to cater for production spreads, the actual loop gain will have to be limited at some frequencies to even less than $\frac{1}{4}$.

The easiest way of reducing gain is to reduce the collector load. This is formed by the transformed impedance of the diode and the tuned circuit dynamic impedance in parallel. Perhaps the best way to explain this is by means of an equivalent circuit. The one shown in Fig. 10(a) is a π equivalent circuit obtained from the hybrid π found in most transistor data sheets and in the literature. When unilateralized, the capacities can be absorbed into the tuned circuits and the internal feedback is cancelled. Thus the equivalent circuit becomes Fig. 10(b).

So in order to get the maximum power gain from the stage, the aerial circuit is matched into R_{in} , and the diode impedance is transformed up to the collector output impedance, R_{out} . The tuned circuit is also in the collector circuit, and introduces a loss resistance in shunt with the other resistors as in Fig. 10(c).

The value of the load resistor can be arranged to reduce the forward gain to the value required for stability in a production amplifier. But the author found that a much larger proportion of the available gain can easily be obtained in individual cases, such as where the constructor can effect some adjustment to the circuit. This adjustment consists mainly of ensuring correct neutralization and perhaps reducing the collector load to give stability. This has to be done with the selectivity of the circuits borne in mind. The bandwidth of a tuned circuit is defined as f_0/Q . With two tuned circuits the overall bandwidth is ≈ 0.6 times the bandwidth of

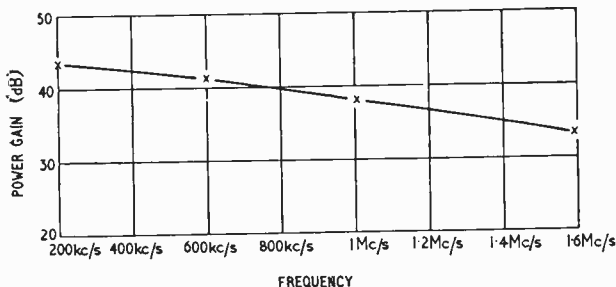

Fig. 9. Maximum power gain/frequency curve with matched load and unilateralization.

each circuit. Thus to get 9kc/s overall bandwidth at 1Mc/s a working Q_w of 65 is needed. It is necessary to ensure that Q_w is not too high, thus cutting top notes, or too low, thus giving the chance of an interfering station intruding.

In a practical case R_{out} is 28 k Ω and R_L is 28 k Ω . Assuming the best coil which can be easily wound has a Q_o of 130, then using a tuning capacitor of 100pF at 1Mc/s will give a dynamic impedance of $Q_o/\omega C = 200k\Omega$. To get a working Q_w of 65 this means damping by a resistance of 200k Ω . This damping comes from the parallel value of R_{out} and R_L (14k Ω). So the transformer ratio between tuned circuit and collector is $\sqrt{200/14} = 3.8$ to 1. Or in other words the dynamic impedance of the tuned circuit is reflected into the collector circuit as 14k Ω , thus absorbing four times as much power as the load, or introducing a 6-dB power loss. So using values from the OC44 data in the equivalent circuit Fig. 11(a):—

Volts across load = $gm V_i$ (parallel load) = $20 \times V_i \times 7 = 140V_i$.

$$\text{Power in load} = \frac{V^2}{R_L} = \frac{(140V_i)^2}{28 \times 10^3}$$

$$\text{Power in Base} = \frac{V_i^2}{R_{in}} = \frac{V_i^2}{2.7 \times 10^3}$$

$$\therefore \text{Power Gain} = \frac{140^2 \times 2.7}{28} = 1900$$

or $10 \log 1900 = 32.7\text{dB}$.

This value seems to be realizable in practice, as long as the stage is perfectly neutralized. But if a value of neutralizing capacitor is chosen, using the nominal value of collector feedback capacitor, the constructor could have an out-of-balance feedback capacitor of 3.5pF, due to tolerance on the internal collector feedback capacitor alone, besides the usual 20% component tolerance. The equivalent circuit now becomes Fig. 11(b).

Here it can be seen that the output voltage is attenuated by the reactance of the 3.5pF and the input circuit of the transistor. At 1Mc/s this attenuation is $(X_c + 1.35)/1.35 = 34$. The forward gain is 140, so the loop gain is high and if the phase is correct oscillation can occur. Even if oscillation does not occur the shape of the selectivity curve may become distorted. But the home constructor will be able to rectify this by reducing the collector load as mentioned. Also if the collector load is reduced by reflecting a lower impedance from the diode the working Q_w must be borne in mind, and a lower tap on the coil may have to be used, which in turn will reflect a lower impedance into the collector circuit. This is brought out in the following example:—

A forward voltage gain of 34 will give a loop gain of 1, and so stability is just theoretically possible. Voltage gain = $gm \times$ total load, therefore load = $34/20 = 1.7k\Omega$. So with a total collector load of 1.7k Ω and the coil again introducing a loss of 6dB, the coil loss resistance being equal to the load resistance, we get Fig. 12.

As was done before, the coil needs to be damped by 200k Ω to give the correct Q_w . This damping comes from R_{out} and R_L in parallel. The transformer ratio is $\sqrt{200/3.2} = 7.9$ to 1. The power gain will have dropped to $3.4^2 \times 2.7/3.6 = 870$, or $10 \log 870 = 29.3\text{dB}$.

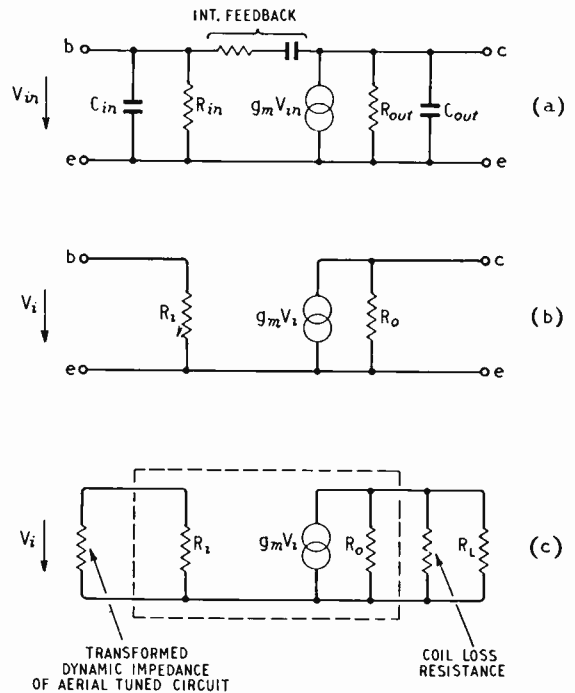

Fig. 10. The π equivalent circuit of a unilateralized transistor r.f. stage shown at (a), simplified by absorbing capacitances in tuned circuits at (b) and with addition of tuned-circuit loss resistance at (c).

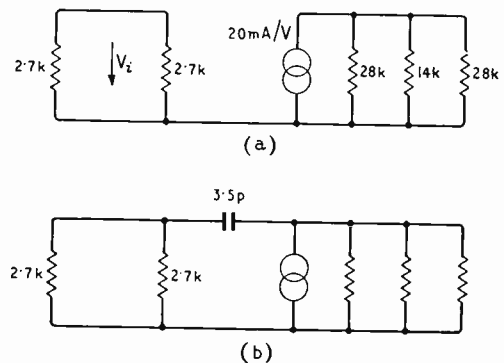

Fig. 11. Equivalent circuit values of r.f. stage (a) unilateralized at 1Mc/s and (b) with some out-of-balance feedback due to imperfect neutralization.

This lower gain gives a loop gain of 1 at 1Mc/s, but if the variations of output and input impedance are taken into account, as the frequency changes, the design gets rather complicated. The author found it easier to get the maximum gain by matching the stage correctly and with accurate neutralization the stage was stable at all frequencies.

Coming now to the practical circuit; in the table are the various parameters at different frequencies for $I_c = 0.5\text{mA}$, $V_{ce} = 6\text{V}$, with $I_c = 0.5\text{mA}$ giving the smallest variation of these parameters over the band.

As can be seen, the transformer ratio for a perfect match varies considerably with frequency, whereas the neutralizing capacitor remains constant and as this needs to be fed from the diode winding to give

correct phase, it confines the design to one chosen ratio.

So using 1Mc/s as the design frequency:—
 Turns ratio (collector/diode) = 1.65 to 1.
 Thus defining our neutralizing capacitor as $10.3 \times 1.65 = 17\text{pF}$ and resistor as $2.5/1.65 = 1.5\text{k}\Omega$:—
 Turns ratio (tuned circuit/collector) = 3.8 to 1.

This was arrived at when the case for maximum power transfer was worked out. With a Q_o of 130 and 100-pF tuning capacitor, this means an L of $250\mu\text{H}$. To cover the medium waveband 50 to 250pF tuning capacitance will be required.

With the usual small dust-cored coil formers this requires approximately 110 turns on a former $\frac{3}{8}$ in dia using 9/45 Litz wire in order to get a Q_o around 130. The collector is tapped in at 29 turns and the diode winding has 18 turns wound the same sense and preferably wound on first to get a good coupling coefficient. In practice the coil is one winding of 128 turns with tappings at 18 and 47 turns from the "earthy" end of the coil, then the two wires of the first tap are separated and become the finish of the diode winding and the beginning of the collector winding respectively, bearing in mind the correct phase for neutralization.

Unless a wave-winding machine is available the easiest way to wind the coils is between two discs of good quality insulant, stuck $\frac{1}{4}$ in apart on the former. On the long waves at 200kc/s we select a preferred value of 470pF for the tuning capacitor, then L = 1.3mH, which is not too difficult to wind. This gives a dynamic impedance of $130\text{k}\Omega$ if $Q_o = 80$. Here the collector-to-diode ratio must still be 1.65 to 1 for neutralization considerations and the

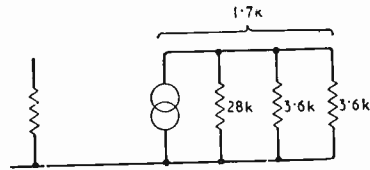

Fig. 12. Part of equivalent circuit showing collector load for a loop gain of one.

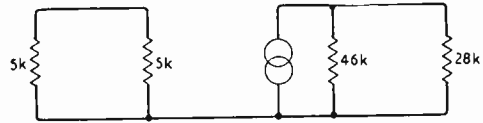

Fig. 13. Equivalent circuit of unilateralized r.f. stage at 200kc/s.

equivalent circuit then becomes as shown in Fig. 13.

To reduce the Q_o of the coil to a half, its dynamic impedance, referred to the collector, has to be equal to the parallel load, which is $28 \times 46/74 = 17.5\text{k}\Omega$. Giving a tuned circuit/collector ratio of $\sqrt{130/17.5} = 2.7$ to 1. There is not a lot to be gained by winding this coil with Litz as the working Q_w does not need to be very high to give the same bandwidth. In fact it works out at $Q_w = 15$, so perhaps in order to avoid top note cut on the long waves the coil should be more heavily damped, but the author has not found this really necessary.

The longwave tuned coil is wound with No. 40 s.w.g., s.s.c. (or EN.) and requires 300 turns for an inductance of 1.3mH. The total winding consists of 367 turns tapped at 67 and 177 turns thus providing the separate diode winding, collector winding and remainder of the tuned winding. With $R_{in} = 5\text{k}\Omega$, $R_{out} = 46\text{k}\Omega$, $gm = 20\text{mA/V}$:—
 Volts across load = $gm V_i \times 8.75\text{k}\Omega = 175V_i$.

$$\text{Power in } R_L = \frac{(175V_i)^2}{28 \times 10^3}$$

$$\text{Power in Base} = \frac{V_i^2}{R_{in}} = \frac{V_i^2}{5\text{k}\Omega}$$

$$\therefore \text{Power gain} = \frac{175^2 \times 5}{28} = 5,500 \text{ or } 10 \log 5,500 =$$

37dB.

Stability is better than in the medium wave case because the reverse attenuation is now $(X_c + 2.5)/2.5 = 91$.

Aerial Stage.—There now only remains the aerial circuit to discuss. This is very simple as almost any commercial ferrite-rod aerial will do, as long as a check on the coupling winding is carried out. These aerials have an extremely high Q_o , of the order 250 to 300, giving a dynamic impedance of $450\text{k}\Omega$ at 1Mc/s with 100pF tuning capacitance, so to match to the input impedance of $2.7\text{k}\Omega$ at 1Mc/s the ratio will be $\sqrt{450/2.7} \approx 12$ to 1. Thus, for a practical medium-wave coil the windings consist of 60 turns of 9/45 Litz with 5 turns of No. 40 En for the coupling coil; the number of turns on the coupling coil is so small that it is easy to adjust on test should the matching be in doubt.

If the aerial is constructed at home the coupling windings should be on the inside of the tuned circuit winding, at the earthy end, and as shown in

Table of Relevant Parameters at $V_{cc} = 6\text{V}$, $I_c = 0.5\text{mA}$

Frequency	1.5Mc/s	1.0Mc/s	650kc/s	200kc/s
R_{in}	1.7k Ω	2.7k Ω	3.7k Ω	5k Ω
R_{out}	18k Ω	28k Ω	36k Ω	46k Ω
Internal feedback capacitance C	10.3pF \pm 3.5pF	10.3pF \pm 3.5pF	10.3pF \pm 3.5pF	10.3pF \pm 3.5pF
Internal feedback resistance R	2.5k Ω	2.5k Ω	2.5k Ω	3.5k Ω
gm	20mA/V	20mA/V	20mA/V	20mA/V
Collector/diode ratio =	$\sqrt{\frac{18}{10}} = 1.3$ to 1	$\sqrt{\frac{28}{10}} = 1.65$ to 1	$\sqrt{\frac{36}{10}} = 1.9$ to 1	$\sqrt{\frac{46}{10}} = 2.1$ to 1
Collector output imped.				
Diode input imped.				
Diode imped. = 10k Ω				
Aerial/base ratio =	$\sqrt{\frac{600}{1.7}} = 18$ to 1	$\sqrt{\frac{400}{2.7}} = 12$ to 1	$\sqrt{\frac{300}{3.7}} = 9$ to 1	$\sqrt{\frac{180}{5.0}} = 6$ to 1
Circuit dynamic imped.				
R_{in} (transistor)				

Fig. 14. On the long waves, and the highest medium-wave frequency to be received, no trimmers are used in the aerial circuit, tuning being accomplished by sliding the coils along the ferrite rod. The number of turns for the ferrite-rod aerial will depend, of course, on the grade and make of ferrite used. Those given in Fig. 14 should be taken as a guide only and if during the initial tests a variable capacitor is employed, either in place of the fixed 100pF and 470pF capacitors or in parallel with them it will soon be evident if any adjustment is necessary.

In describing the stage the neutralizing capacitor has been calculated as 18pF; this could be a fixed capacitor. But if a transistor with its internal feedback capacitance near the tolerance limit is used, a fixed neutralizing capacitor may cause oscillation. A simple way of ensuring perfect neutralization is as follows:—

The supplies are left on the transistor and if it is in oscillation before the check is carried out, then oscillation must be stopped by temporarily connecting a resistor across the tuned circuit. Then a signal generator is connected, via a resistor (in order to pad up the signal generator impedance), to the diode winding. Now a portion of the signal will be fed back to the base via the neutralizing components and also through the transistor internal feedback, and by means of a valve voltmeter or oscilloscope the fraction which arrives at the base, due to out of balance in the two feedback paths,

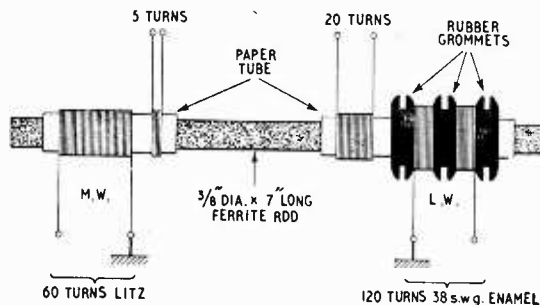

Fig. 14. Winding layout on ferrite-rod aerial.

can be reduced to a minimum by adjusting the neutralizing capacitor and resistor. The capacitance will be found to be the more critical. See that the aerial and collector circuits are correctly tuned and finally check once more with the damping resistor removed.

The author hopes that prospective constructors will be able to follow the design details; and if a transistor other than the OC44 is used the manufacturer should be able to supply the relevant parameters.

The receiver has proved a most useful "second set" for use anywhere in the house or out of doors, its zero warm-up time and simple station selection being greatly appreciated by the family.

FORTHCOMING MEETINGS

Tickets are required for some meetings; readers are advised therefore to communicate with the secretary of the society concerned.

LONDON

Oct. 22nd. Television Society.—Discussion on "New television standards: their effect on British television" at 7.0 at the Cinematograph Exhibitors' Association, 164 Shaftesbury Avenue, W.C.2.

Oct. 22nd. Institution of Production Engineers.—"Computers as applied to production control" by B. L. J. Hart at 7.0 at Royal Commonwealth Society, Northumberland Avenue, Strand, W.C.2.

Oct. 27th. I.E.E.—Discussion on "Future trends in memory stores for high-speed digital computers" opened by W. Renwick at 5.30 at Savoy Place, W.C.2.

Oct. 27th. Radar and Electronics Association.—"Electronics in supersonic flight" by F. W. Page (English Electric Aircraft Division) at 7.30 at the Royal Society of Arts, John Adam Street, W.C.2.

Oct. 28th. I.E.E.—"Development of Eurovision" by M. J. L. Pulling, chairman, Electronics and Communications Section, at 5.30 at Savoy Place, W.C.2.

Oct. 28th. Brit.I.R.E.—Inaugural meeting of Radar and Navigational Aids Group: "Radio—its impact on shipping" by Capt. J. D. F. Elvish and "A historical survey of radar and radio aids to aircraft navigation", by Air Marshal Sir Raymond Hart at 6.30 at the London School of Hygiene and Tropical Medicine, Keppel Street, W.C.1.

Oct. 30th. Junior Institution of Engineers.—"Planning a computer job"

by M. G. Ferrand at 7.0 at Pepsys House, 14 Rochester Row, Westminster, S.W.1.

Oct. 31st. B.S.R.A.—Stereo Symposium from 10.30 a.m. at the London School of Hygiene and Tropical Medicine, Keppel Street, W.C.1.

Nov. 2nd. I.E.E.—"Some comments on the classification of waveguide modes" by Dr. A. E. Karbowiak and "Some comments on quasi-optical methods at millimetre wavelengths" by L. Lewin at 5.30 at Savoy Place, W.C.2.

Nov. 3rd. I.E.E.—"An analogue electronic multiplier using transistors as square-wave modulators" by P. Glegghorn at 5.30 at Savoy Place, W.C.2.

Nov. 4th. Brit.I.R.E.—Computer Group half-day symposium on "Input/output devices" at 3.0 and 6.0 at the London School of Hygiene and Tropical Medicine, Keppel Street, W.C.1.

Nov. 4th. British Kinematograph Society.—"Magnetic tape for video and audio recording" by Dr. G. F. Dutton (E.M.I.) at 7.30 at the Colour Film Services Ltd. Theatre, 22-25 Portman Close, Baker Street, W.1.

Nov. 6th. I.E.E.—Medical Electronics Discussion Group meeting at 6.0 at Savoy Place, W.C.2.

Nov. 6th. Television Society.—"Deflection techniques for 110° picture tubes" by B. Eastwood (Siemens Edison Swan) at 7.0 at the Cinematograph Exhibitors' Association, 164 Shaftesbury Avenue, W.C.2.

Nov. 9th. I.E.E.—"Theory of the

travelling-wave parametric amplifier" by Professor A. L. Cullen; "The gain of travelling-wave ferromagnetic amplifiers" by Dr. P. J. B. Clarricoats; "Some properties of travelling-wave resonance" by J. R. G. Twisleton and "Saturation effects in a travelling-wave parametric amplifier" by A. Jurkus and P. N. Robson at 5.30 at Savoy Place, W.C.2.

Nov. 11th. Brit. I.R.E.—Medical Electronics Group meeting on "Physiological and acoustical aspects of hearing" by Dr. R. P. Gannon at 6.30 at the London School of Hygiene and Tropical Medicine, Keppel Street, W.C.1.

Nov. 12th. Physical Society, Acoustics Group.—"The propagation of Rayleigh waves" by G. Mott and "Wave propagation in crystals" by M. J. P. Musgrave at 4.0 at Imperial College, Prince Consort Road, S.W.7.

Nov. 13th. Junior Institution of Engineers.—"Electronic components" by W. C. C. Ball (chairman) at 7.0 at Pepsys House, 14 Rochester Row, Westminster, S.W.1.

Nov. 18th. Brit.I.R.E.—Half-day symposium on "Electronic digitizing techniques" at 3.0 and 6.0 at the London School of Hygiene and Tropical Medicine, Keppel Street, W.C.1.

Nov. 20th. Television Society.—"Television film production" by J. K. Byers (B.B.C.) at 7.0 at the Cinematograph Exhibitors' Association, 164 Shaftesbury Avenue, W.C.2.

Nov. 20th. B.S.R.A.—"Loudspeakers" by S. Kelly at 7.15 at the Royal Society of Arts, John Adam Street, W.C.2.

Nov. 24th. Radar and Electronics Association.—“Waveguides for long-distance communications” by Professor H. M. Barlow (University College, London) at 7.30 at the Royal Society of Arts, John Adam Street, W.C.2.

Nov. 25th. I.E.E.—“Radio aspects of the International Geophysical Year” by Dr. R. L. Smith-Rose at 5.30 at Savoy Place, W.C.2.

ABERDEEN

Nov. 13th. I.E.E.—“The application of transistors to line communication equipment” by H. T. Prior, D. J. R. Chapman and A. A. M. Whitehead at 7.30 at Robert Gordon's Technical College.

BIRMINGHAM

Oct. 26th. I.E.E.—“Reliability of electronic equipment” by A. G. Field at 6.0 at the James Watt Institute.

Nov. 13th. Society of Instrument Technology.—“Ultrasonic inspection techniques” by W. B. Emms at 7.0 in the Lecture Theatre of the Byng Kendrick Suite at the Gosta Green College of Technology, Aston Street.

BRISTOL

Nov. 18th. Brit.I.R.E.—“Data recording and presentation” by D. W. Thomasson at 7.0 at the School of Management Studies, Unity Street.

CAMBRIDGE

Nov. 3rd. I.E.E.—“The development of Eurovision” by M. J. L. Pulling at 8.0 at the Cavendish Laboratory, Free School Lane.

CARDIFF

Oct. 28th. Brit.I.R.E.—“Stereophonic sound and electrostatic loudspeakers” at 6.30 at Cardiff College of Advanced Technology.

CHELTENHAM

Nov. 3rd. Society of Instrument Technology.—“Satellite instrumentation” by S. J. Collins at 7.30 at the Belle Vue Hotel.

CHESTER

Oct. 29th. Society of Instrument Technology.—“Industrial uses of computers” by R. H. Tizard at 7.0 at the English-Speaking Union, Stanley Place, Watergate Street.

DUNDEE

Nov. 12th. I.E.E.—“The application of transistors to line communication equipment” by H. T. Prior, D. J. R. Chapman and A. A. M. Whitehead at 7.0 in the Electrical Engineering Department, Queen's College.

EDINBURGH

Oct. 23rd. Brit.I.R.E.—“True motion radar” by J. H. Beattie at 7.0 at Department of Natural Philosophy, The University, Drummond Street.

Nov. 12th. Brit.I.R.E.—“The transistor and its use in communication and control equipment” by E. Wolfendale at 7.0 at the Department of Natural Philosophy, The University, Drummond Street.

FARNBOROUGH

Oct. 20th. I.E.E.—“Space research” by Dr. R. L. F. Boyd at 6.0 at the Technical College, Boundary Road.

GLASGOW

Oct. 22nd. Brit.I.R.E.—“True motion radar” by J. H. Beattie at 7.0 at Institution of Engineers and Shipbuilders, 39 Elmbank Crescent, C.2.

Oct. 27th. I.E.E.—“Ultra-sound

image camera” by Dr. C. N. Smyth and J. Sayers at 6.0 at the Royal College of Science and Technology, George Street, C.1.

Nov. 4th. I.E.E.—The Fiftieth Kelvin Lecture on “The Geophysical Year 1957-58” by Sir David Brunt at 6.0 at the Institution of Engineers and Shipbuilders, 39 Elmbank Crescent, C.2.

Nov. 11th. Brit.I.R.E.—“The transistor and its use in communication and control equipment” by E. Wolfendale at 7.0 at the Institution of Engineers and Shipbuilders, 39 Elmbank Crescent, C.2.

LIVERPOOL

Nov. 2nd. Brit.I.R.E.—“Electronics in the auto-pilot of the Firestreak missile” by A. Bedford at 7.0 at the University Club.

Nov. 10th.—Brit.I.R.E.—“The use of transistors in communications and control” by E. Wolfendale at 7.0 at the University Club.

Nov. 11th. I.E.E.—“Vision and position—two electronic aids to marine navigation” by Dr. R. B. Mitchell and C. Powell at 6.0 at The Temple, Dale Street (joint meeting with the Liverpool Engineering Society).

MALVERN

Oct. 27th. Brit.I.R.E.—“Superconducting computer stores” by Mrs. Lois Roberts at 7.0 at the Winter Gardens.

MANCHESTER

Nov. 10th. Society of Instrument Technology.—“Transistors” by S. S. Goldberg at 6.45 at the “Manchester Room,” Central Library, St. Peter's Square.

Nov. 11th. I.E.E.—“Ultra-sound image camera” by Dr. C. N. Smyth and J. Sayers at 6.15 at the Engineers' Club, Albert Square.

Nov. 12th. Brit.I.R.E.—“Progress in permanent magnet materials” by J. E. Gould at 6.30 at the Reynolds Hall, College of Science and Technology, Sackville Street.

MIDDLESBROUGH

Nov. 12th. Society of Instrument Technology.—“Analogue computers” by R. E. Hare at 7.30 at the Cleveland Scientific & Technical Institute, Corporation Road.

NEWCASTLE

Nov. 11th. Brit.I.R.E.—“Electronic welding controls” by C. R. Bates at 6.0 at the Institution of Mining and Mechanical Engineers, Neville Hall, Westgate Road.

Nov. 18th. Society of Instrument Technology.—“The Principles and manufacture of junction transistors” by P. I. Nicolson at 7.0 in The Conference Room, Roadway House, Oxford Street.

RUGBY

Nov. 11th. I.E.E.—“The Universe explored by radio astronomy” by F. C. Smith at 6.30 at the Rugby College of Technology and Arts.

SALISBURY

Nov. 11th. I.E.E.—“The planning and installation of a television transmitting station” by D. B. Weigall at 6.30 at S.E.B. Showrooms, 17 New Canal.

WOLVERHAMPTON

Nov. 11th. Brit.I.R.E.—“Recent developments in semiconductor rectifiers” at 7.15 at the Wolverhampton and Staffordshire College of Technology, Wulfruna Street.

Two Trix models

PROVED
and
IMPROVED

COLUMN TYPE LOUDSPEAKER

An all-round improvement in acoustic efficiency, permitting smaller powered amplifiers... a distinct directional flat beam effect extending coverage while sharply reducing reverberation and feedback effects. One Trix column replaces with greater efficiency a large number of normal speaker units with a corresponding reduction in installation costs. For all sound installations superb clarity of reproduction is assured for both speech and music.

Write for detailed technical information.

RIBBON MICROPHONE

Now smaller, this new design gives improved performance, minimizing feedback effects while improving frequency response and sensitivity.

Model G7823 is complete with screened connector plug and locking ring, and beautifully finished in satin chrome. A silent switch adaptor G7819 is also available.



TRIX

THE TRIX ELECTRICAL CO. LTD.,
1-5 MAPLE PLACE LONDON, W.1.

Tel: MUSeum 5817 (6 lines)
Gram: Trixadio Weso London

RANDOM RADIATIONS

By "DIALLIST"

Pay As You View

IT'S interesting to learn that the American Federal Communications Commission has at long last agreed for a trial of pay-as-you-view television for a limited period in one specified area. In a country where there are no TV licence fees and where the programmes are so interlaced with advertising matter that several "kill that commercial" muting devices operated from the viewer's armchair have been brought out, one would think that the P.A.Y.V. system has a good chance of success. Here's how the Zenith subscription TV system, to be used in these "trials," works. The broadcast transmissions are scrambled and receivable only by those whose sets are fitted with a decoder. This can be added to any set. Each subscriber receives every week a programme of the matter to be provided and the cost of viewing any item. He reads, let's say, that the opening night of a musical is to be televised. He puts the money stated in the programme schedule into slots in the decoder and has an armchair view of the "opening night." It could be a very great success, for if the response was good, very expensive programmes could be put on without any commercial backing. Half a million people, for instance, paying the equivalent of a shilling apiece

would bring in £25,000. Don't you feel that even though we have to pay licence fees the idea might be worth thinking about for our own third TV service?

What Can be Cured Shouldn't be Endured

HAVE you noticed how few non-technical users of sound and television receivers ever bother to read the book of words supplied with every set? You're pretty sure to have done so and like myself I imagine you're constantly being surprised by the indifferent reception that people put up with simply and solely because they won't take the trouble to use the control knobs as the instruction book directs. These books are very carefully prepared and many of them are quite admirable. Ekco, to take one example, illustrate a number of typical results of faulty adjustments to their television set and explain which control is to be used to put each to rights. A few days before this was written I dropped in to see some friends, who told me they feared they would have to call in the dealer because the television picture wasn't right. When I asked what was amiss they switched on the set and showed me that the picture was too narrow. "Have you got the instruction book?" I asked. After some searching in drawers it

was produced. I flicked over the pages and handed the book back, pointing to one of the illustrations, which showed too narrow a picture and directed the use of the width control. Urged on by me they used it and all was well.

Too Many Inside

THERE seems to be a tendency for TV receiver manufacturers or some of them at any rate, to reduce the number of outside-the-cabinet control knobs and to tuck more and more of them away in the bowels of their products. I'm all for making television sets look neat and tidy, but the number of controls which can usefully be of the pre-set variety is definitely limited. As valves age their characteristics change and both resistors and capacitors are liable to alterations in their values as time goes on. Here's a case to illustrate my point. A while ago a friend told me that his picture had become over narrow and that the circle on the test card appeared to be egg-shaped. Easy enough, thought I; a real do-it-yourself job. I bade him find a knob labelled "width" or possibly "line amplitude" at the back of his set, and to twiddle that slowly until things became right. Next time I met him he told me that there wasn't such a knob and that he'd had to send for his dealer. "Took the back off," he said, "and went right into the innards of the set to make the adjustment." That doesn't seem right to me, for it means unnecessary work for the serviceman and expense for the set owner.

A Warning

And there's more to it than just that. Putting too many controls inside the cabinet may tempt the set owner to get busy himself in the works—and that's a risky job unless you know your way about a TV set. Even if you do, there's still an important thing that isn't always done; make sure before you get to work that the chassis isn't "hot." A simple way of doing that is to use a neon tester; but remember that if it doesn't glow, that is not proof positive that the chassis won't bite. The neon bulb might be broken. Make sure by applying the tester to

"WIRELESS WORLD" PUBLICATIONS



	Net Price	By Post
RADIO DATA CHARTS. R. T. Beatty, M.A., B.E., D.Sc. Revised by J. Mc. G. Sowerby, B.A., A.M.I.E.E. 5th Edition	10/6	11/6
TELEVISION RECEIVING EQUIPMENT. W. T. Cocking, M.I.E.E. 4th Edition	30/-	31/9
TRANSISTOR A.F. AMPLIFIERS. D. D. Jones, M.Sc., D.I.C., and R. A. Hilbourne, B.Sc.	21/-	21/10
LONG-WAVE AND MEDIUM-WAVE PROPAGATION. H. E. Farrow, Grad.I.E.E.	4/6	4/10
RADIO VALVE DATA. Compiled by "Wireless World." 6th Edition	5/-	5/9
RADIO CIRCUITS: A Step-by-Step Survey. W. E. Miller, M. A. (Cantab.), M.Brit.I.R.E. Revised by E. A. W. Spreadbury, M.Brit.I.R.E.	15/-	15/10
FOUNDATIONS OF WIRELESS. M. G. Scroggie, B.Sc., M.I.E.E. 7th Edition	15/-	16/4
SECOND THOUGHTS ON RADIO THEORY. "Cathode Ray" of "Wireless World."	25/-	26/4
PRINCIPLES OF TRANSISTOR CIRCUITS. S. W. Amos, B.Sc. (Hons.), A.M.I.E.E.	21/-	21/11

A complete list of books is available on application.

Obtainable from all leading booksellers or from

ILIFFE & SONS LTD., Dorset House, Stamford Street, London, S.E.1

a point which should be live, such as the phase contact of the wall socket.

Say "Ah"

SOMETHING entirely new in the way of stethoscopes is announced by Faraday Electronic Instruments Ltd. It's claimed that it enables its user to hear only what he wants to hear and to cut out undesired sounds. Any layman who has ever been allowed by a doctor to use his stethoscope to listen to, say, a beating heart, knows the extraordinary jumble of gasping, rumbling and creaking noises which come through along with the beats. The Soniscope, as it is called, has a crystal microphone with a heavy diaphragm which responds only to sounds coming from something with which it's in contact; it won't, for instance, pick up speech if only an inch or two from the lips, though it will do so if placed against the jaw or the neck. Separation of wanted from unwanted sounds is done by means of h.f. and l.f. attenuators. Speaking as one with no claim to any medical knowledge, I'd have thought that lots of skill and practice would be needed for it to be used purely for diagnosis, for it does seem possible that some significant noise might inadvertently be tuned out as unwanted. But there's no doubt about its usefulness for demonstration purposes for it can be connected to an amplifier and a loud-speaker.

Hi-Fi in Geophysics

HI-FI is all the rage today and the label is to be found on equipment in unexpected places. Geophysics is the latest realm it has invaded—or should I say embellished? The American Southwestern Electronics Co. has recently announced a 24-channel transistorized seismic system, providing high-fidelity frequency-modulated tape recordings from the output of standard geophysical amplifiers. I don't know enough about the seismic aspect of geophysical research to grasp the exact significance of hi-fi as applied to it; but I imagine that the presence of "noise" and distortion in recordings might seriously impair results and possibly introduce more or less important errors. Anyhow, if you're a seismic geophysicist, hi-fi is there waiting for you. The distortion is less than 1 per cent, the signal-to-noise ratio 60 dB r.m.s. and the timing accuracy is 0.2 millisecond. The whole outfit consists of two units, weighing respectively 50 lb and 40 lb.

Television makes many demands on men and equipment

Instantaneous response and complete reliability are keynotes to the success of the vast Television Industry, it being necessary for the complex equipment used to give a constant high standard of performance under the many conditions imposed.



BULGIN COMPONENTS fulfil these requirements and their use makes possible new techniques—which in their turn are opening up fields of research which were undreamed of a few years ago.

The skill of the BULGIN Research division is unparalleled and its unique experience is at YOUR disposal.



OVER 10,000 COMPONENTS AVAILABLE

Send for Catalogue No. 200 (add suffix 'C' for priority) which gives complete technical and illustrative details of our entire range. (1/6 Post free, or free to trade letterhead or order.)

BULGIN

FOR QUALITY COMPONENTS

**A. F. BULGIN & CO. LTD.
BARKING, ESSEX**

Telephone: RIPPleway 5588
(12 lines)



LIST No. J.6



LIST No. D.780/Colour



LIST No. F.167



LIST No. D.58



LIST No. S.530



LIST No. K.435



LIST No. S.600/PD



LIST No. S.725

UNBIASED

By FREE GRID

P. A. Pioneer

PUBLIC ADDRESS is so much a feature of an election campaign such as the one we have recently endured that it is hard to recall a time when it was non-existent. The first election campaign in which I personally recollect a *commercial* p.a. system being used was at the by-election in Marylebone during April, 1928. But loudspeakers were used by candidates a long time before that.

I speak subject to correction, but I believe the loudspeaker was first introduced into politics by F. H. Haynes when Assistant Editor of this journal. I well remember him making an amplifier and loudspeaker—the term public address was not then used—for the candidate of his choice in one of the St. Pancras divisions. I recollect listening to the—by 1959 standards—rather lo-fi output of the loudspeaker, and mentally deciding that the Brobdignagian bellowings of the loudspeaker were more likely to be a hindrance than a help to the candidate. I believe, however, I am right in saying that the candidate was duly elected despite the efforts of the loudspeaker.

It is possible, however, that a loudspeaker was used for electioneering before the creation of the Haynes p.a. outfit. It is even possible that a loudspeaker could have been used in pre-B.B.C. days. The B.B.C. began its continuous broadcasting by giving the election results on November 14th, 1922. If, indeed, a loudspeaker was used by any candidate in that election it was probably the Stentorphone which I personally recollect hearing on the pier at New Brighton in August, 1921. This instrument was what I would call a *magneto-pneumatic amplifier-cum-loudspeaker*. Can any reader recall its use or the use of any other type of loudspeaker in the general elections of 1922, 1923 and 1924?

Electrocussion

I WONDER if any of my medical readers can tell me if the human body acquires a tolerance of electric shocks in the same way as it does of certain drugs such as alcohol.

Everybody knows that it does not take much in the way of alcoholic refreshment to release the inhibitions of a teetotaler. A couple of drinks in a pub would cause him to exchange badinage with the barmaid and chuck her under the chin with a boldness that would make even a hardened drinker aghast. I am not a total abstainer but a very moderate drinker and I know the effects of that sort which a couple of drinks has on me.

The reason I am wondering if the body acquires a tolerance of electric shocks is that nowadays I find I am able to withstand shocks with a non-

chalance envied by many a leading light of the I.E.E. I have received a fair number of shocks, electric and otherwise, in the course of my life, and I am wondering whether my seemingly growing tolerance is real, or is it that with advancing years my skin is growing drier, or maybe my nervous system less sensitive.

To a large extent, of course, my tolerance of shocks is psychological. I have had plenty of them without any real harm, and therefore when I receive one I do not imagine I ought to lose consciousness or maybe die.



Badinage with the barmaid

Maybe I could eventually build up a sufficient psychological tolerance to continue living after being electrocussed (not electrocuted please) in the electric chair in Sing-Sing.

Unlike myself many people have been brought up to regard electric shocks as so lethal that when they receive what I would regard as a trivial one, they become really ill because, I suppose, their minds tell them they *ought* to be ill. I daresay that if many people, myself included, were given an injection of a few drops of distilled water but were told they were being given knock-out drops, they would lose consciousness.

However, I don't really know what I am talking about and that is why I ask for help from my medical readers.

Single-channel Stereo

THE cost of a stereogram for use with the new 3-D discs is necessarily rather high as almost everything except the cabinet has to be duplicated. I have, therefore, been racking my brains to see if I can devise a method of using one amplifier for both channels. Impossible, you say? Maybe so, but I am old enough to recollect the days when the price of valves was so high—to say nothing of the 12s 6d royalty on each valveholder in a set—that a way had to be devised of making one valve do the work of two. The result was the reflex receiver.

Now, we can't feed both stereo channels into one amplifier simul-

aneously but let us suppose we fixed up an automatic changeover switch working at, say, 50 "cycles" per second so that the input of the amplifier was connected first to one pick-up channel output and then to the other, and, of course, the amplifier output first to one loudspeaker and then to the other a few feet away. All we should get would be a horrible noise rather worse—if that be possible—than the wibbly-wobbly sound made by a cinema organ with the tremolo in use.

We could, of course, get rid of the wobble by using an electronic changeover switch working at super-sonic frequency of change. However, there would, I think, be no proper stereo effect but only a curious mixed sound, as our auditory perception would be too slow to "follow" the rapid changeover from one channel to the other.

To my mind, a better idea would be to stick to the lower frequency of 50 changes per second and try to get rid of the wobble by arranging that No. 2 channel was switched into circuit at the exact millisecond that No. 1 was switched out or even a millisecond or two before it was switched out, this would obviously mean that twice in each cycle of events both channels would be heard simultaneously for a millisecond or two. There would, therefore, still be a bit of a ukelele-like wobble, but look how many people like the sound of ukeleles and wobbly cinema organs. The whole thing would probably be a great hit and cheaper than true two-channel stereo.

Seff or Keff

I HAD occasion recently to attend one of the most famous of the London teaching hospitals for the purpose of having my brains tested or, in other words, to have an encephalographic examination. After having been unceremoniously bundled from pillar to post as seems to be the rule in all large establishments, medical or otherwise, I found myself in the chilling presence of one of those super-technical modern nurses who looked at me as if I were something unpleasant the cat had brought in.

In my confusion under her frigid gaze I mumbled something about an encephalograph examination, only to be implicitly corrected by this very superior daughter of Hippocrates as she repeated the word encephalograph with withering emphasis on the "k" which she substituted for the "c." This stung me to instant retaliation as I said "Yes, my local physician sent me."

If the medical profession really want to pronounce "c" as a "k" when used before "e" or "i" then let them *spell* it with a "k" as physicists do with kinetic, which, of course, belongs to the same family group as cinema.